

moree

ENHANCING AMBIANCE

COLLECTION 2017



ESCAPE/
AMSTERDAM/ HOLLAND
©WWW.DENNISVELDMAN.NL / WWW.ESCAPE.NL

ÜBER MOREE ABOUT MOREE A PROPOS DE MOREE

DE Moree ist Spezialist für hochwertige Lichtmöbel und Wohnraum-Accessoires, gemacht für Menschen, die sinnliches wie urbanes Wohnen schätzen. Aus der Liebe zu klaren Formen, innovativen Materialien und der Faszination für die Wirkung von Licht schöpfen die Moree Designer immer neue Ideen für ausdrucksstarkes wie zeitloses Interieur & Exterieur.

Moree steht für formschöne und hochfunktionale Qualitätsprodukte, welche im ausgesuchten Einrichtungs- und Designfachhandel in über 30 Ländern erhältlich sind.

Das Sortiment basiert zudem auf einer umfangreichen Kollektion an Leuchttischen und Sitzmöbeln für alle Anwendungsbereiche der Gastronomie und Hotellerie.

Wir bieten Ihnen auch die Möglichkeit, unsere Möbel individuell zu bedrucken und somit Marken oder Botschaften prominent zu positionieren. Individuell, aufmerksamkeitsstark und faszinierend.

EN Moree is a specialist for high-quality illuminated furniture and living room accessories, made for people who appreciate sensual, urban living. The love of clear forms, innovative materials combined with a fascination for the effect of light, Moree designers are always exploring expressive and timeless ideas for interiors and exteriors.

Moree combines exquisite form with highly functional products, available in over 30 countries in selected furnishing and design stores.

The range is based on an extensive collection of illuminated tables and seating for all areas of the hospitality industry.

Moree furniture can be branded individually, giving companies and product advertisements high visibility. Unique, eye-catching and intriguing.

FR Moree est le spécialiste des meubles lumineux et accessoires pour les intérieurs de classe. Nos produits s'adressent aux amateurs d'une ambiance sensuelle et urbaine. Les designers de Moree s'inspirent de leur amour pour les formes claires, les matériaux innovants et de leur passion pour les jeux de lumière pour créer des intérieurs et extérieurs expressifs et intemporels.

Moree est signe de produits de qualité élégants et parfaitement fonctionnels qui sont proposés dans les magasins de meubles et de design de plus de 30 pays.

La gamme est basée sur une vaste collection de tables lumineuses et meubles d'assise pour tous les domaines d'application de la gastronomie et de l'hôtellerie.

La possibilité d'appliquer des impressions individuelles sur nos meubles afin de transporter des marques ou messages de manière exceptionnelle constitue un autre atout. Individuels, attractifs et fascinants.



MATERIALIEN MATERIALS MATERIAUX

DE Um das anspruchsvolle Qualitätsniveau und die Langlebigkeit der Produkte zu garantieren, werden ausschließlich hochwertige Materialien wie Stahl, Aluminium, Glas, Holzwerkstoffe und Filz verarbeitet. Die einzigartigen, transluzenten Komposit-Kunststoffe wurden exklusiv für Moree entwickelt und produziert.

Moree hat sich bewusst für den Produktionsstandort Deutschland entschieden. Das Design, die Entwicklung und die Herstellung werden somit hauptsächlich in Zusammenarbeit mit deutschen Partnern realisiert. Hohe Qualitätsstandards und kurze Lieferzeiten stehen im Vordergrund.

EN To guarantee the demanding level of quality and durability of our products, only high-quality materials such as steel, aluminum, glass, wood and felt are used. The unique, translucent polymer composites that we use have been developed and produced exclusively for Moree.

We have deliberately chosen Germany for the production location - thus design and development are mainly in cooperation with German partners. High quality standards and short delivery times are our priority.

FR Nous garantissons le niveau de qualité et la durabilité de nos produits par l'emploi exclusif de matériaux de toute première qualité: acier, aluminium, verre, matériaux dérivés du bois, feutre. Les matières plastiques translucides uniques en leur genre sont développées et fabriquées pour Moree en exclusivité.

Moree a délibérément retenu l'Allemagne comme site de production. Le design, le développement et la fabrication sont donc pour la plupart assurés en collaboration avec des partenaires allemands. La priorité est accordée aux standards de qualité stricts et aux délais de livraison courts.



LICHT LIGHT LUMIÈRE

DE Erst durch Licht werden Farben, Materialien, Formen und die Dimension von Räumen visuell wahrnehmbar, der richtige Umgang mit Licht ist entscheidend für die Wirkung des Raumes. Zudem ist Licht wie kein anderes visuelles Medium in der Lage Emotionen zu beeinflussen.

Moree konzentriert sich auf innovative LED-Technologie in Symbiose mit seinen Produkten. Die LED-Module werden mittels Fernbedienung gesteuert und ermöglichen unzählige Farben, Helligkeiten und vielfältige Effekte auf Knopfdruck. Licht und Farbe eröffnen neue Gestaltungsdimensionen im Design und machen die Faszination der Moree-Produkte aus.

EN Only through light can colours, materials, shapes and spaces be visually perceived, and light, like no other medium can influence your emotions in any situation. The correct handling of light is crucial for the effect in any environment.

Moree focuses on innovative LED technology in symbiosis with its products. The LED modules are remote controlled which enable endless colours, brightness's and a variety of effects right at your fingertips. Light and colour are what make Moree products so intriguing, and open up new dimensions in our designs.

FR Seule la lumière donne une âme aux couleurs, matériaux, formes et dimensions des intérieurs. Les effets qu'un intérieur peut produire dépendent largement de la gestion adéquate de la lumière. Et il ne faut pas oublier que la lumière n'a pas sa pareille parmi les médias visuels s'il s'agit d'influencer les émotions.

Moree se concentre sur la technologie DEL innovante en une symbiose parfaite avec ses produits. Les modules DEL sont télécommandables. D'innombrables couleurs, luminosités et effets variés peuvent ainsi être créés sur une simple pression de touche. La lumière et les couleurs ouvrent des horizons nouveaux au design et rendent les produits de Moree si fascinants.



LEGENDE/ LEGEND/ LÉGENDE



Verwendung im Innenbereich
Indoor use
Pour utilisation intérieur



Verwendung im Aussenbereich
Outdoor use
Pour utilisation extérieur



Produkt mit Kabel
Product with cable
Produit avec câble



Produkt mit Batterie
Product with battery
Produit avec batterie



Mit Fernbedienung
With remote control
Avec commande



Schutzart
Ingress Protection
Indice de protection



E27 Fassung
E27 socket
E27 douille de lampe



USB Ports
USB Ports
USB Ports



Kabel-Stauraum Funktion
Cable Organizer Function
Fonction: Stockage Câble



Ohne Licht
Without light
Sans Lumière



LED-Leuchtmittel (Multicolor & Weiß)
LED source (Multicolor & White)
Ampoule LED (Multicouleurs & Blanc)

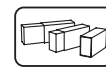

Eraser Helligkeitsregulierung
Eraser dimming
Eraser contrôle de la luminosité



Beleuchtung für Vorderseite und Arbeitsplatz
Front and workspace illumination
Lumière pour avant et espace de travail

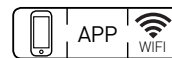

Moree 2.4 GHz LED-Produkte*, die per App über Smartphones/ Tablets gesteuert werden können. Die Moree-App ist kostenlos im AppStore oder Android Google Play™ erhältlich.

Smartphones/ tablets able to control Moree 2.4 GHz LED Products* via WIFI using App available on The AppStore or Android Google Play™.

Moree 2.4 GHz LED produits* peuvent être contrôlés par l'application sur Smartphones/ Tablettes. (Moree application disponible gratuitement sur l'AppStore ou Android Google Play™)



* 9W LED Multicolor Bulb, LED, LED Pro, LED Pro Accu Produkte/ Products/ Produits

MODULARE BELEUCHTETE THEKE/ MODULAR
 ILLUMINATED BAR/ BAR MODULABLE LED INTÉGRÉE

Bar 08

LEUCHTTISCHE/ ILLUMINATED TABLES/
 TABLES LUMINEUSES

Studio 36/ 45/ 75/ 105 10
 Ora 12
 Ora Home 14
 Lounge 45/ 55/ 75/ 105 16
 Lounge M 45/ 55/ 75/ 105 18
 Lounge 20
 Lounge Mini 22
 Lounge Variation 24

SMART & MULTIFUNKTIONALE MÖBEL/
 SMART & MULTI-FUNKTIONAL FURNITURE/
 MEUBLES SMART & MULTI-FONCTIONS

Bubble 26
 Bubble Granite 28
 Cube 30
 Cube Granite 32
 Cooler 34
 Lounge Mini Cable Organizer 22
 Lounge Variation 24
 Ora Home 14

LEUCHTEN/ LAMPS/ LAMPES

Alice 36
 Alice XL 38
 Alice 30/ 50 40
 Shark 42
 Eraser 260/ 380 44

BARHOCKER/ BAR STOOL/ TABOURET DE BAR

Ed 46

2.4 GHZ PRODUKTE/ 2.4 GHZ PRODUCTS/ 2.4 GHZ PRODUITS

9W RGBW LED-Leuchtmittel/ 9W RGBW LED Light bulb/ 9W Ampoule LED RGBW 48
 Funk Fernbedienung/ Radio Remote Control/ Télécommande RC 49
 App & WIFI-Controller / App & WIFI Controller/ App & Contrôleur WIFI 49

TECHNISCHE DATEN/ TECHNICAL DATA/ CARACTÉRISTIQUES TECHNIQUES 50

KONTAKT/ CONTACT/ A CONTACTER 67

PROJEKTE/ PROJECTS/ PROJETS 68



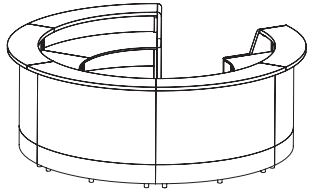

08 | BAR

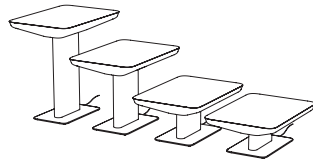

10 | STUDIO

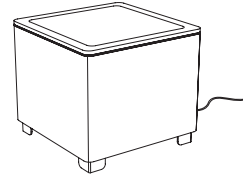

12 | ORA

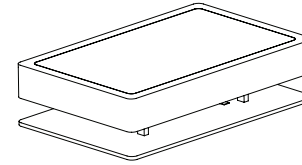

14 | ORA HOME



16 | LOUNGE 45/55/75/105



18 | LOUNGE M 45/55/75/105

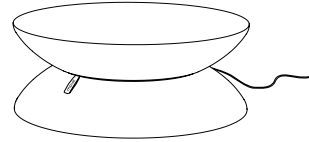

20 | LOUNGE

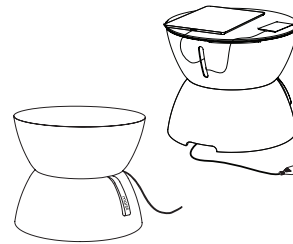

22 | LOUNGE MINI
22 | CABLE ORGANIZER

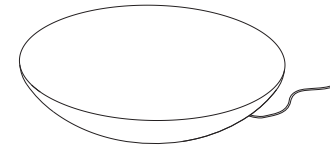

24 | LOUNGE VARIATION

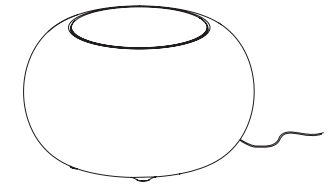

26 | BUBBLE
28 | BUBBLE GRANITE

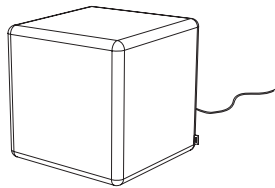

30 | CUBE
32 | CUBE GRANITE



34 | COOLER

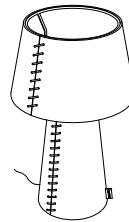

36 | ALICE

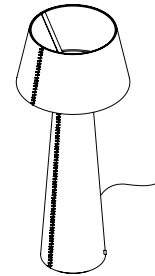

38 | ALICE XL

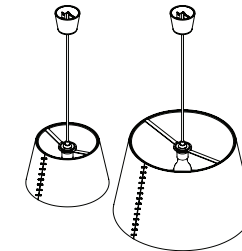

40 | ALICE 30/50

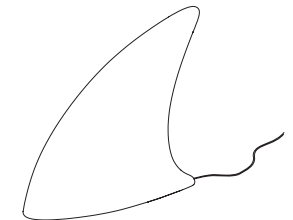

42 | SHARK

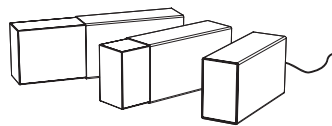

44 | ERASER

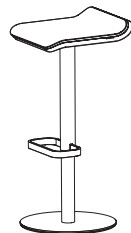

46 | ED



48 | 9WRGBWLIGHTBULB



49 | REMOTE CONTROL



49 | APP & WIFI CONTROLLER

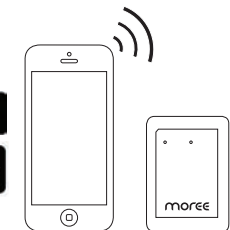



BAR

MODULARE BELEUCHTETE THEKE
MODULAR ILLUMINATED BAR
BAR MODULABLE LED INTEGRÉE

NEW

BEISPIELE/ EXAMPLES/ EXEMPLES

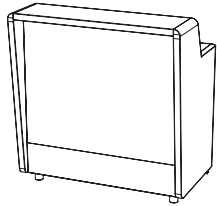

1X MODULE +
1X ENDCAP LEFT+ 1X ENDCAP RIGHT

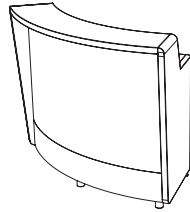

1X MODULE 60° +
1X ENDCAP LEFT+ 1X ENDCAP RIGHT

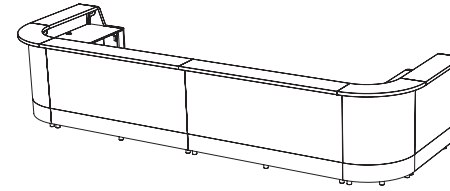

2X 2M MODULE + 2X MODULE 90° + 2X 1M
MODULE + 1X ENDCAP LEFT+ 1X ENDCAP RIGHT

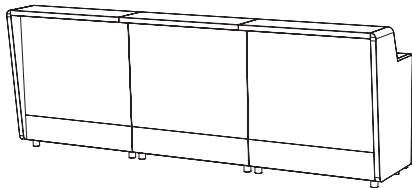

3X 1M MODULE +
1X ENDCAP LEFT+ 1X ENDCAP RIGHT

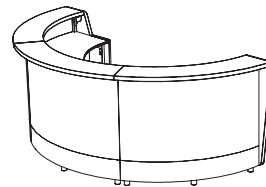

3X MODULE 60° +
1X ENDCAP LEFT + 1X ENDCAP RIGHT

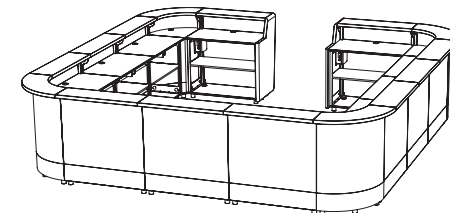

4X MODULE 90° + 11X 1M MODULE + 1X ENDCAP
LEFT+ 1X ENDCAP RIGHT

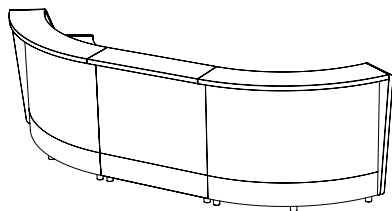

1M MODUL + 2X MODUL 60°
1X ENDCAP LEFT+ 1X ENDCAP RIGHT

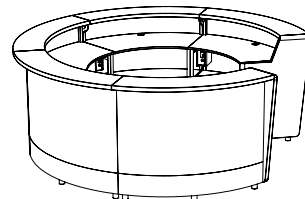

5X MODULE 60° +
1X ENDCAP LEFT + 1X ENDCAP RIGHT

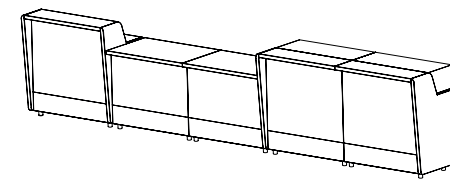

3X 1M MODUL + 2X BUFFET 86 + 2X BUFFET 110 +
2X ENDCAP LEFT + 2X ENDCAP RIGHT

FUNKTIONEN

- DUALE MULTICOLOR LED-BELEUCHTUNG für Vorderseite und Arbeitsplatz
- 4-Kanal Funk-Fernbedienung
- Schnelle Verbindung von Modulen
- Einfaches Einhängen der Endstücke
- Kabelmanagement
- Einlegeböden festschraubbar
- Justierbare Füße
- Rollen mit Bremse (optional)
- Kühlschrank (optional)
- Spülbecken (optional)

FEATURES

- DUAL LED LIGHTS for front and work space
- 4-channel radio remote control
- Fast connection of modules
- Easy attachment of endcaps
- Cable management
- Screw in shelves
- Adjustable feet
- Wheels with brake (optional)
- Fridge (optional)
- Sink (optional)

FONCTIONS

- DOUBLE LUMIÈRE pour led avant et espace de travail
- 4 canaux télécommande radio
- Connexion rapide des modules
- Mettre facile des embouts
- Management des câbles
- Étagères à vis
- Pieds réglables
- Roulettes avec frein (en option)
- Réfrigérateur (en option)
- Lavabo (en option)

08 | 09

BAR



Material/ Farbe: Holz, weiß beschichtet seidenmatt/ Endstücke weiß lackiert/ seidenmatt
Material/ Colours: Wood, white satin coated/ white satin spray painted
Matériaux/ Couleur: Bois avec revêtement, satin blanc/ Bois laqué, blanc satin

moree
enhancing ambience



STUDIO 36/45/75/105

DESIGNTISCH-SERIE FÜR EIN URBANES WOHNGEFÜHL
 DESIGNER TABLE SERIES FOR URBAN LIVING
 SÉRIE DE TABLE DESIGN POUR LA VIE URBAINE



10 | 11

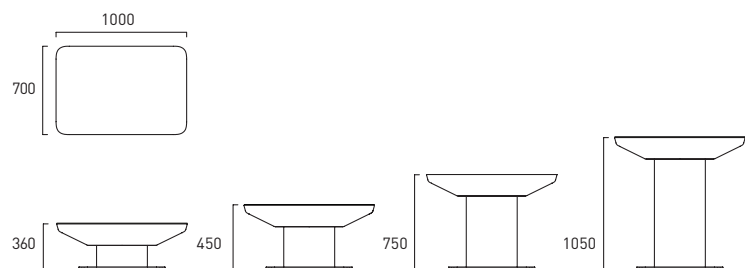

Material/ Farbe: ABS, PMMA glänzend, UV-beständig/ weiß, transluzent; Edelstahl gebürstet
 Material/ colours: ABS, PMMA, glossy, UV resistant/ white, translucent; stainless steel brushed
 Matériaux/ couleur: ABS, PMMA, brillant, résistant aux rayons UV/ blanc, translucide; acier inoxydable brossé

moree
 enhancing ambience

STUDIO X

INDOOR

LED PRO

LED PRO ACCU

OUTDOOR

OUTDOOR LED





ORA

ZEITLOSES DESIGN
TIMELESS DESIGN
DESIGN INTEMPOREL



12 | 13

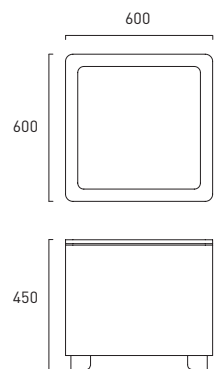

AVAILABLE IN
20+ COLOURS!



Material/ Farbe: Holz, lackiert, weiss/ schwarz seidenmatt/ Walnuss Echtholz-Funier
Material/ colours: Wood, painted, satin white/ black/ real walnut veneer
Matériaux/ couleur: Bois, laqué, blanc/ noir satin/ noyer placage de bois véritable

ORAX LED



LED ACCU



LED PRO ACCU





ORA HOME

LED COUCHTISCH MIT STYLISCHEM STAURAUUM & 2 USB-PORTS
LED COFFEE TABLE WITH STYLISH STORAGE SPACE & 2 USB PORTS
TABLE BASSE LED AVEC ESPACE DE STOCKAGE ÉLÉGANT & 2 PRISES USB



NOW WITH
2x USB PORTS!



14 | 15

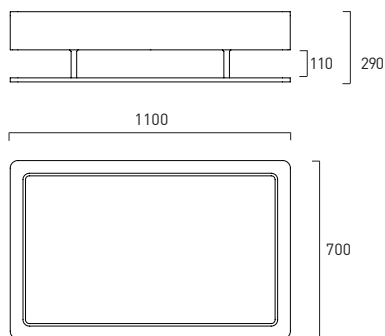

Material/ Farbe: Holz, lackiert/ Weiß, seidenmatt; Glasplatte, tranzluzent
Material/ Colours: Wood, spray painted/ White, satin; Glass top, translucent
Matériaux/ Couleur: Bois, laqué/ Blanc satin; Tablette en verre, translucide



ORA HOME (X) ORA HOME LED PRO



Das Produkt wird ohne iPad und iPad Zubehör geliefert.
Product does not come with iPhone/ iPad accessories.
Le produit est livré sans iPad et ses accessoires.



LOUNGE 45/55/75/105

EINZIGARTIGER DESIGNTISCH
A UNIQUELY DESIGNED TABLE
TABLE AU DESIGN UNIQUE

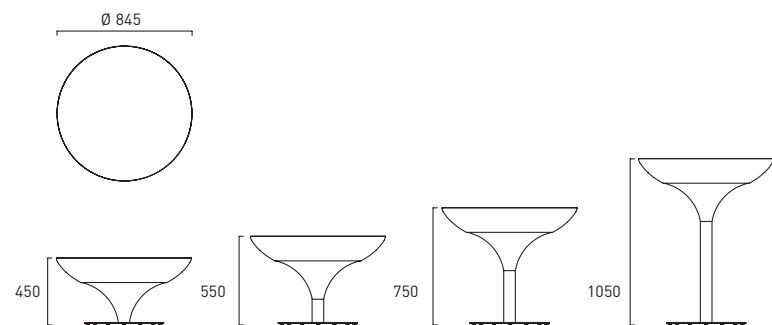

Material/ Farbe: ABS, PMMA glänzend, weiß transluzent, UV-beständig; Aluminium gebürstet
Material/ colours: ABS, PMMA glossy, white translucent, UV resistant; aluminium brushed
Matériaux/ couleur: ABS, PMMA brillant, blanc, translucide résistant aux rayons UV; Aluminium brossé

LOUNGE X

INDOOR

LED PRO



LED PRO ACCU



OUTDOOR

LED PRO OUTDOOR



LED ACCU OUTDOOR





LOUNGE M 45/ 55/ 75/ 105

LICHTQUELLE UND BLICKFANG
AN EYE CATCHING SOURCE OF LIGHT
UNE SOURCE DE LUMIÈRE ACCROCHEUSE

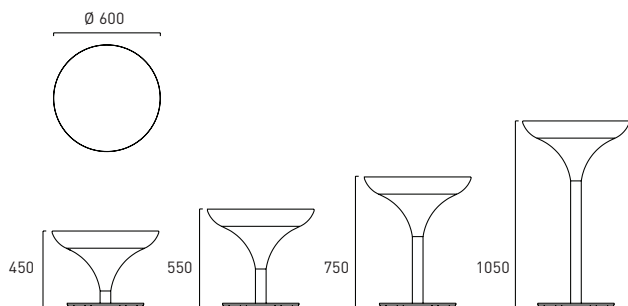

Material/ Farbe: ABS, PMMA glänzend, weiß transluzent, UV-beständig; Aluminium gebürstet
Material/ colours: ABS, PMMA glossy, white translucent, UV resistant; aluminium brushed
Matériaux/ couleur: ABS, PMMA brillant, blanc, translucide résistant aux rayons UV; Aluminium brossé, anodisé

LOUNGE MX INDOOR



INDOOR LED



LED PRO ACCU



OUTDOOR



OUTDOOR LED



LED ACCU OUTDOOR





LOUNGE

LICHT UND FORM IN PERFEKTEM EINKLANG
LIGHT AND FORM IN PERFECT HARMONY
LUMIÈRE ET FORME, EN PARFAITE HARMONIE



20 | 21

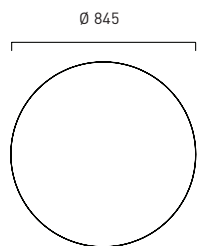

Ø 845

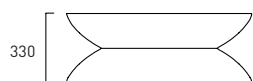

330

Material/ Farbe: ABS, PMMA glänzend, UV-beständig/ weiß, transluzent

Material/ colours: ABS, PMMA, glossy, UV resistant/ white, translucent

Matériaux/ couleur: ABS, PMMA, brillant, résistant aux rayons UV/ blanc, translucide

INDOOR



INDOOR LED



LED PRO ACCU



OUTDOOR



OUTDOOR LED



moree
enhancing ambience



LOUNGE MINI

LOUNGE MINI CABLE ORGANIZER



ALLE KABEL PERFEKT VERSTECKT
CLEAN LIVING AND NO MORE MESSY CABLES
TOUS LES CÂBLES PARFAITEMENT CACHÉS

GOODBYE
CABLE CLUTTER



22 | 23

Ø 390

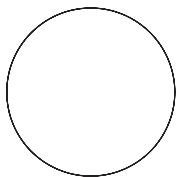

330

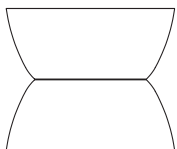

Material/ Farbe: ABS, PMMA glänzend, UV-beständig/ weiß, transluzent
Material/ colours: ABS, PMMA, glossy, UV resistant/ white, translucent
Matériaux/ couleur: ABS, PMMA, brillant, résistant aux rayons UV/ blanc, translucide

LOUNGE MINI

LOUNGE MINI LED

LOUNGE MINI CABLE ORGANISER



Das Produkt wird ohne Verlängerungskabel, Kabel und mobile Geräte geliefert.
Product does not come with accessories.
Le produit est fourni sans la multiprise, les cables et les périphériques affichés.





LOUNGE VARIATION

TISCH AM BODEN, DEKORATION AN DER WAND
TABLE ON THE FLOOR, DECORATION ON THE WALL
TABLE AU SOL, DÉCORATION AU MUR

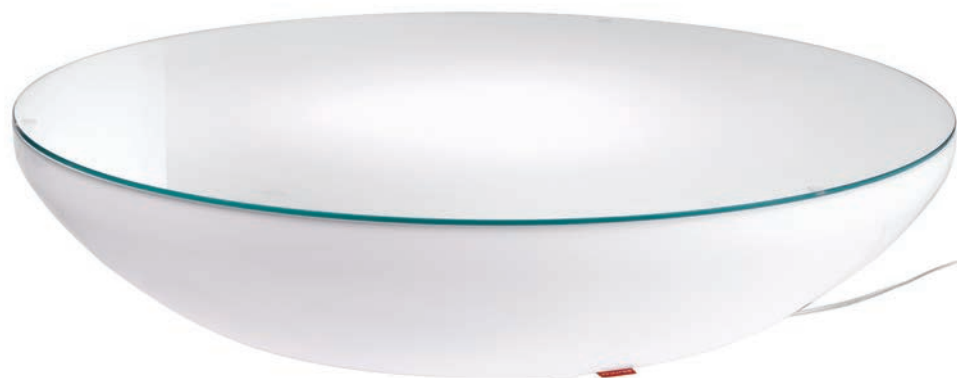

24 | 25

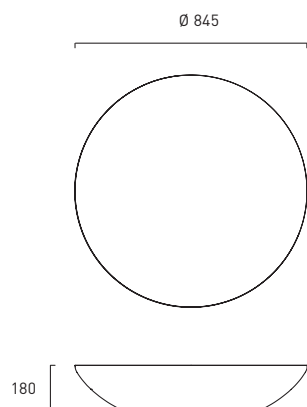

Material/ Farbe: ABS, PMMA glänzend, UV-beständig/ weiß, transluzent
Material/ colours: ABS, PMMA, glossy, UV resistant/ white, translucent
Matériaux/ couleur: ABS, PMMA, brillant, résistant aux rayons UV/ blanc, translucide

INDOOR

INDOOR LED PRO

OUTDOOR

OUTDOOR LED PRO



E27



E27



APP



E27



E27



APP





BUBBLE

ILLUMINIERTER BEISTELLTISCH UND SITZGELEGENHEIT
ILLUMINATED SEAT AND TABLE
ASSISE ET TABLE ILLUMINÉES

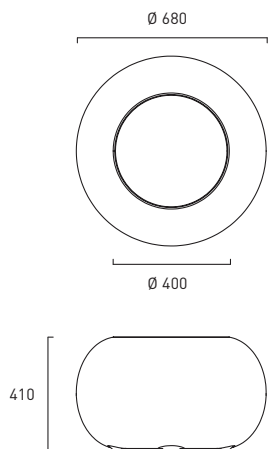

Material/ Farbe: PE seidenmatt, UV-beständig/ weiß, transluzent
Material/ colours: PE semi gloss, UV resistant/ white, translucent
Matériaux/ couleur: PE satiné, résistant aux rayons UV/ blanc, translucide



Glastischplatte
Glasstop
Plateau en verre



Filtzkissen sind erhältlich in Orange, Rot, Violett, Grün, Anthrazit.
Felt cushions available in orange, red, purple, green, anthracite.
Coussins en feutre disponibles en orange, rouge, violet, vert, anthracite.

BUBBLE X

INDOOR

INDOOR LED



LED PRO ACCU

OUTDOOR

OUTDOOR LED



LED ACCU OUTDOOR





BUBBLE GRANITE

ILLUMINIERTER BEISTELLTISCH UND SITZGELEGENHEIT
 ILLUMINATED SEAT AND TABLE
 ASSISE ET TABLE ILLUMINÉES

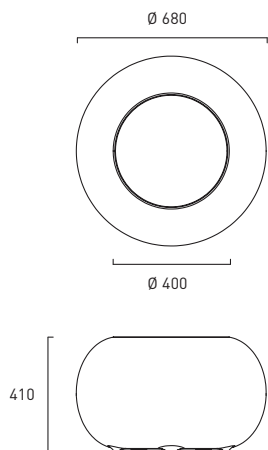

28 | 29



Material/ Farbe: PE seidenmatt, UV-beständig/ weiß, transluzent
Material/ colours: PE semi gloss, UV resistant/ white, translucent
Matériaux/ couleur: PE satiné, résistant aux rayons UV/ blanc, translucide

Glastischplatte
Glasstop
Plateau en verre

Filtzkissen sind erhältlich in Orange, Rot, Violett, Grün, Anthrazit.
Felt cushions available in orange, red, purple, green, anthracite.
Coussins en feutre disponibles en orange, rouge, violet, vert, anthracite.

BUBBLE X

INDOOR

INDOOR LED

OUTDOOR

OUTDOOR LED





CUBE

INNOVATIVES SITZMÖBEL, TISCH UND DEKORATIONSOBJEKT
 INNOVATIVE SEAT, TABLE AND DECORATIVE OBJECT
 OBJET DÉCORATIF D'ASSISE, DE TABLE OU DE DÉCORATION



NEW Mod. 09-01-04
 CUBE LED ACCU OUTDOOR

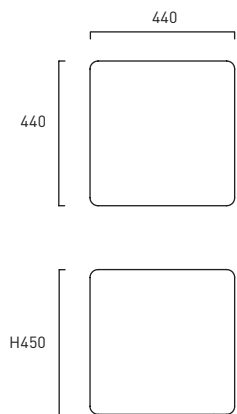

Material/ Farbe: PE seidenmatt, UV-beständig/ weiß, transluzent
Material/ colours: PE semi gloss, UV resistant/ white, translucent
Matériaux/ couleur: PE satiné, résistant aux rayons UV/ blanc, translucide

NEW CUBE ACCESSORIES!



Für das Produkt "Cube" sind eine Glastischplatte oder Filzkissen erhältlich, welche jedoch extra bestellt werden müssen und NICHT im Preis enthalten sind.
Available for the product "Cube" are a glass tabletop or felt cushions, which must be ordered separately and are not included in the price.
Disponible pour le produit "Cube" sont un plateau en verre ou des coussins en feutre, qui doivent être commandés séparément et ne sont pas inclus dans le prix.



CUBE GRANITE

INNOVATIVES SITZMÖBEL, TISCH UND DEKORATIONSOBJEKT
 INNOVATIVE SEAT, TABLE AND DECORATIVE OBJECT
 OBJET DÉCORATIF D'ASSISE, DE TABLE OU DE DÉCORATION

NEW Mod. 09-01-04
 CUBE LED ACCU OUTDOOR

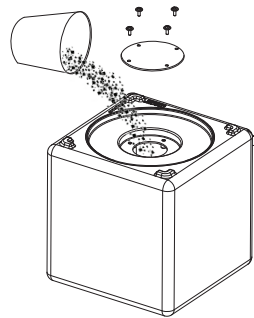
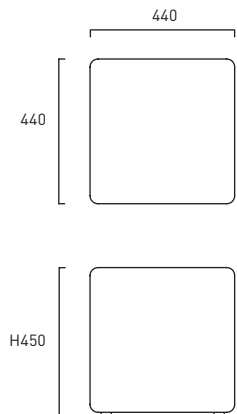

BOLLARD:

- Sand oder Kies einfüllen, um das Gewicht des Bollard zu erhöhen und ein Verschieben/ Diebstahl zu erschweren.
- Fill with sand or gravel to increase the weight of the Bollard and complicate a move or theft.
- Remplir avec du sable ou de gravier pour augmenter le poids du Bollard et empêcher un déménagement ou un vol.

Material/ Farbe: PE seidenmatt, UV-beständig/ weiß, transluzent
Material/ colours: PE semi gloss, UV resistant/ white, translucent
Matériaux/ couleur: PE satiné, résistant aux rayons UV/ blanc, translucide



NEW CUBE ACCESSORIES!



Für das Produkt "Cube" sind eine Glastischplatte oder Filzkissen erhältlich, welche jedoch extra bestellt werden müssen und NICHT im Preis enthalten sind.
Available for the product "Cube" are a glass tabletop or felt cushions, which must be ordered separately and are not included in the price.
Disponible pour le produit "Cube" sont un plateau en verre ou des coussins en feutre, qui doivent être commandés séparément et ne sont pas inclus dans le prix.





COOLER

SOLOAUFTRITT FÜR EDEL-PRICKELNDE TROPFEN
A SOLO PERFORMANCE FOR FINE SPARKLING BEVERAGES
SPECTACLE SOLO POUR LES BOISSONS GAZEUSES

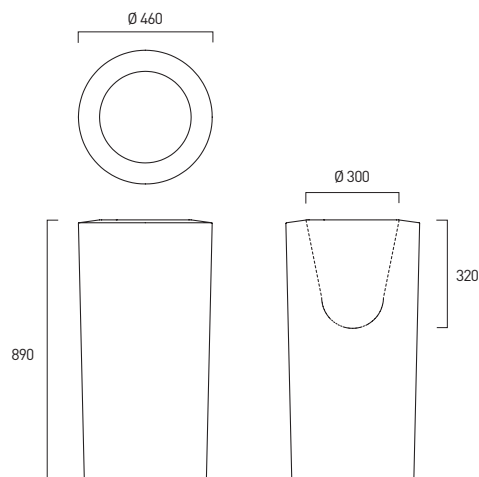

Material/ Farbe: PE seidenmatt, UV-beständig/ weiß, transluzent
Material/ colours: PE semi gloss, UV resistant/ white, translucent
Matériaux/ couleur: PE satiné, résistant aux rayons UV/ blanc, translucide





ALICE

FILZ-LEUCHTE MIT EINEM TWIST FÜR DIE SINNE
FELT LAMP WITH A TWIST ON YOUR SENSES
LUMIÈRE FEUTRE AVEC UNE TORSION SUR VOS SENS

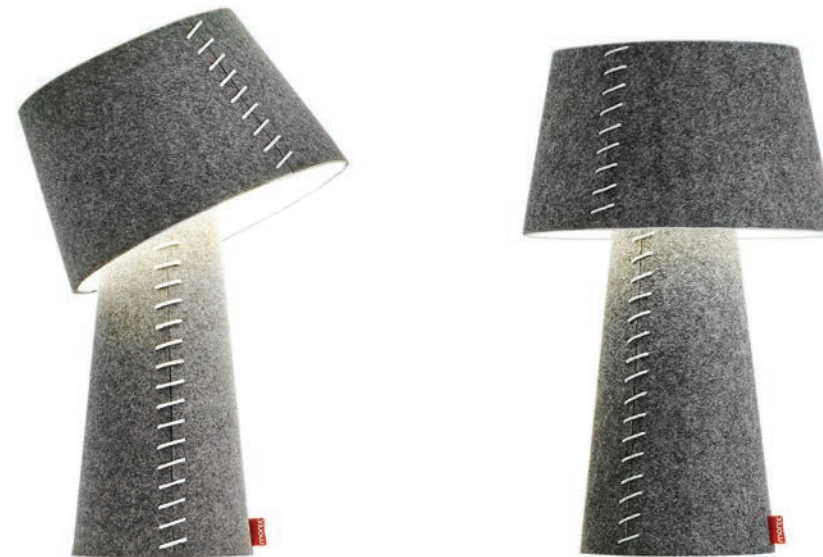
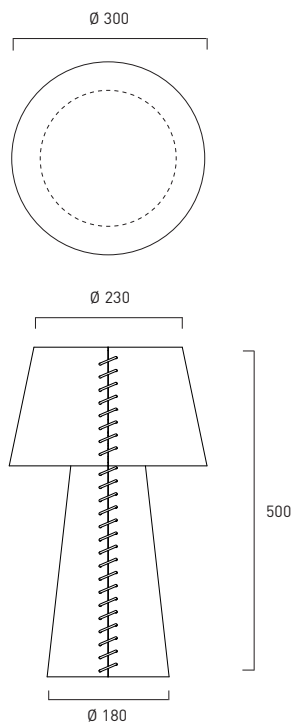

36 | 37

Material/ Farbe: Filz (PE)/ grau
Material/ Colours: Felt (PE)/ grey
Matériaux/ Couleur: Feutre (PE)/ gris

ALICE

ALICE LED





ALICE XL

STEHLEUCHTE AUS FILZ MIT SCHWENKBAREM SCHIRM
STANDING FELT LAMP WITH ADJUSTABLE HEAD
GRAND LAMPADAIRE EN FEUTRE AVEC UNE TÊTE AJUSTABLE

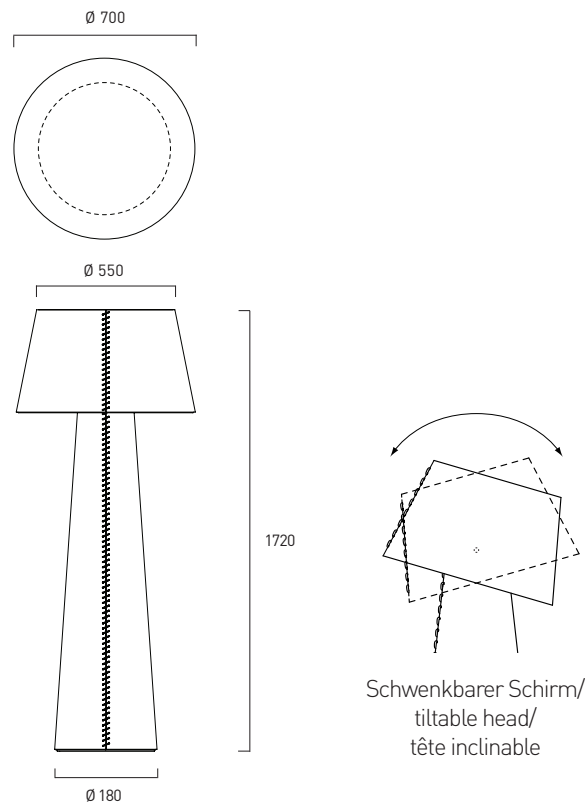

Material/ Farbe: Filz (PE)/ grau
Material/ Colours: Felt (PE)/ grey
Matériaux/ Couleur: Feutre (PE)/ gris

ALICE XL

ALICE XL LED





ALICE 30/50

DIE NEUE ALICE HÄNGT IM MITTELPUNKT
THE FELT PENDANT LAMP IS YOUR NEW CENTRE-PIECE
LA LAMPE PENDANTE ALICE EST LE NOUVEAU CENTRE DE LA PIÈCE

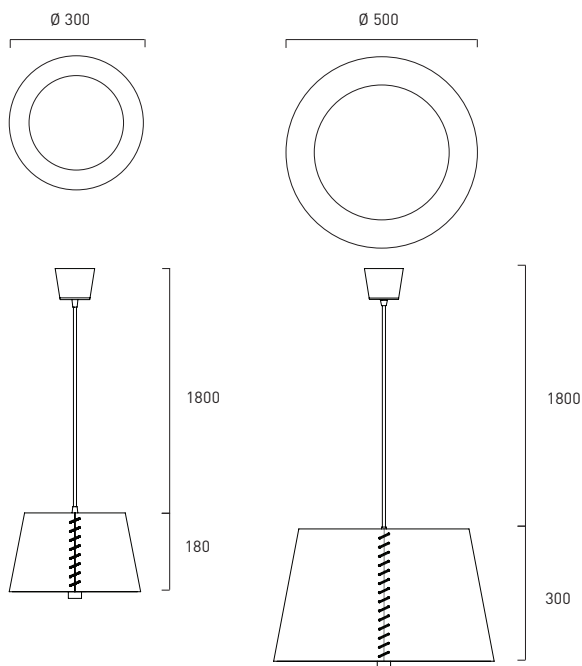

Material/ Farbe: Filz (PE)/ grau
Material/ Colours: Felt (PE)/ grey
Matériaux/ Couleur: Feutre (PE)/ gris

ALICE 30/ 50

ALICE 30/ 50 LED





Design by Aleksandr Mukomelov



SHARK

GEFÄHRLICH SCHÖN
DANGEROUSLY BEAUTIFUL
DANGEREUSEMENT BELLE



FANCY A SWIM?

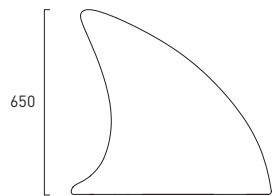
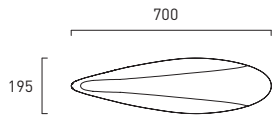

Material/ Farbe: PE seidenmatt, UV-beständig/ weiß, transluzent
Material/ colours: PE semi gloss, UV resistant/ white, translucet
Matériaux/ couleur: PE satiné, résistant aux rayons UV/ blanc, translucide

INDOOR



INDOOR LED

OUTDOOR



OUTDOOR LED



LED ACCU OUTDOOR





Design by Steffen Kehrle & Julia Landsiedl

ERASER 260/ ERASER 380

LICHTQUADER MIT MANUELLER DIMM-FUNKTION
 LIGHTCUBE WITH MANUAL DIMMING FUNCTION
 CUBE LUMINEUX AVEC UN RÉGLAGE MANUEL D'INTENSITÉ.

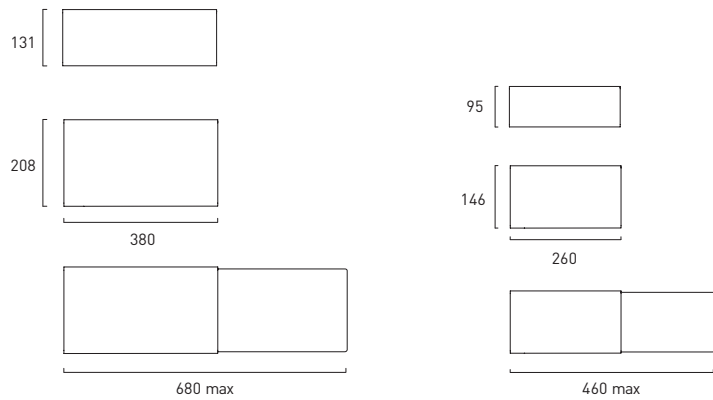
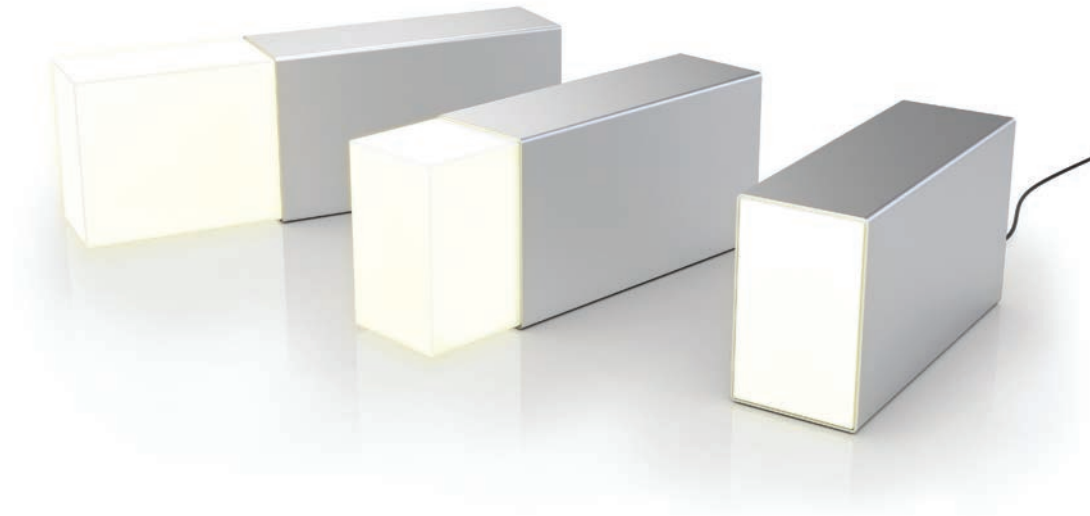

erhältlich in **champagner & silber**
 available in **champagne & silver**
 disponible en **champagne & argent**

Material/ Farbe: Eloxiertes Aluminium, PMMA/ weiß, transluzent
Material/ colours: Anodized aluminium, PMMA/ white, translucent
Matériaux/ couleur: Aluminium anodisé, PMMA/ blanc, translucide

ERASER 260

ERASER 260 LED

ERASER 380

ERASER 380 LED







Mod. 13-02-03

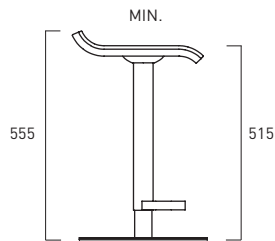
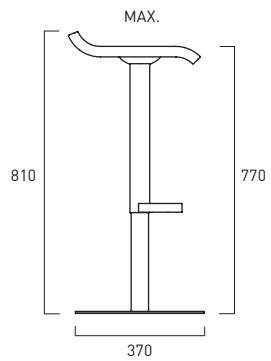
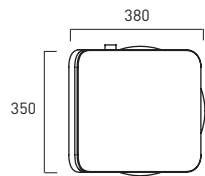

Mod. 13-02-01

**Funktionen**

- Höhenverstellbar
- Im Sitz integrierter Stellhebel
- 360° Rotation des Sitzes

Features

- Adjustable seat height
- In seat integrated lever
- 360 degree rotating seat

Fonctions

- La hauteur d'assise est réglable
- Levier intégré dans le siège
- Pivotant à 360 degrés

Material/ Farbe: Formholz lackiert/ Mittelteil: Stahl pulverbeschichtet+Edelstahl/ Edelstahl-Fuss gebürstet

Material/ colours: Wood painted/ Column: Powder-coated steel+stainless steel/ Brushed stainless steel foot

Matériaux/ couleur: Bois, laqué/ Colonne: Acier revêtement en poudre+acier inoxydable/ Pied en acier inoxydable, brossé

9W RGBW LED LIGHT BULB

9W MULTICOLOR LEUCHTMITTEL STEUERBAR MIT FUNK-FERNBEDIENUNG & MOREE APP
9W MULTICOLOUR LIGHTBULB CONTROLLABLE WITH RADIO REMOTE CONTROL & MOREE APP
9W LUMIÈRE AMPOULE MULTICOULEURS CONTRÔLABLE AVEC TELECOMMANDE RADIO OU BIEN
PAR LE BIAIS D'UN SMARTPHONE/ TABLETTE À L'AIDE DE L'APPLICATION MOBILE DE MOREE

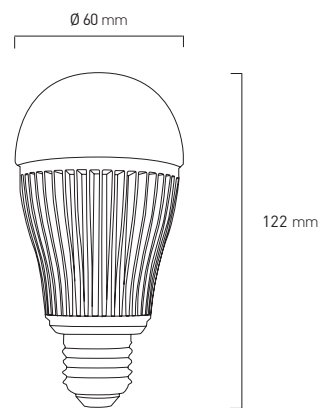

RADIO REMOTE CONTROL (4 CHANNELS) | MOD. 20-02-02
FOR ALL 2.4 GHZ PRODUCTS & RGBW LIGHT BULB



9W RGBW LED LIGHT BULB
MOD. 20-02-01



DOWNLOAD THE
MOREE REMOTE APP
& CONTROL YOUR
2.4GHz PRODUCTS
THROUGH THE
MOREE
WIFI CONTROLLER

MOREE REMOTE APPLICATION (4 CHANNELS)
FOR ALL 2.4 GHZ PRODUCTS & RGBW LIGHT BULB

WIFI CONTROLLER
MOD. 20-02-03

9W MULTICOLOR LED LIGHT BULB



REMOTE & REMOTE APP FUNCTIONS

FERNBEDIENUNG & APP FUNKTIONEN/
TÉLÉCOMMANDE & L'APPLICATION MOBILE FONCTIONS

INDIVIDUAL PRODUCT CONTROL (UP TO 4 CHANNELS PER REMOTE)



MULTIPLE GROUP CONTROL (UP TO 4 CHANNELS PER REMOTE)



MULTIPLE RGBW BULB CONTROL (UP TO 4 CHANNELS PER REMOTE)

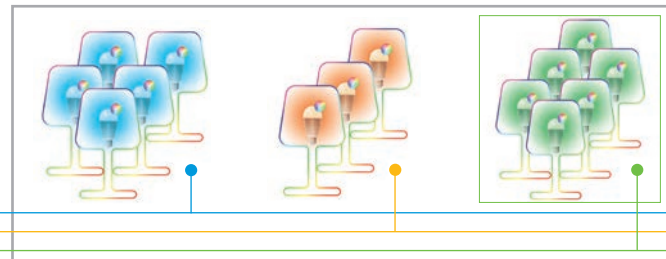

RADIO REMOTE CONTROL (4 CHANNELS) | MOD. 20-02-02
FOR ALL 2.4 GHZ PRODUCTS & RGBW LIGHT BULB

MOREE REMOTE APPLICATION (4 CHANNELS)
FOR THE 2.4 GHZ PRODUCT RANGE & RGBW LIGHT BULB

WIFI CONTROLLER
MOD. 20-02-03

REMOTE CONTROL



APP & WIFI CONTROLLER



BAR

MODULARE BELEUCHTETE THEKE
MODULAR ILLUMINATED BAR
BAR MODULABLE LED INTÉGRÉE

NEW

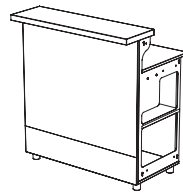

NEW

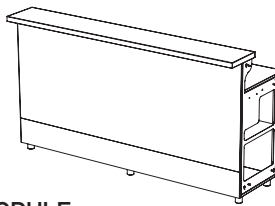

NEW



NEW

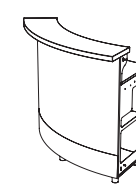

1M MODULE



2M MODULE



90° MODULE



60° MODULE



DE BEISPIEL

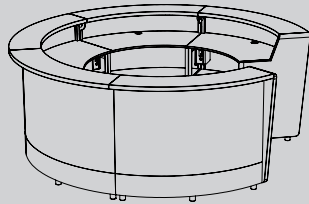

Modell	19-01-01
Material/ Farbe	Holz, furniert Weiß, matt
Maße	L 700 x B 1000 x H 1100 mm
Gewicht	Ca. 32 kg
EE-Klasse	B
Front- Beleuchtung	Multicolour LEDs, max 14 W, max 500 lm, Lebensdauer: 30000 h
Arbeitsflächen- Beleuchtung	Multicolour LEDs, max 14 W, max 500 lm, Lebensdauer: 30000 h
Fernbedienung	Funk, Mod. 20-02-02
Verkabelung	Ca. 4 m, schwarz
Spannung	200-240 VAC, 50 Hz
Schutzklasse	II
IP 20	für Innenbereich geeignet

Modell	19-01-02
Material/ Farbe	Holz, furniert Weiß, matt
Maße	L 700 x B 2000 x H 1100 mm
Gewicht	Ca. 58 kg
EE-Klasse	B
Front- Beleuchtung	Multicolour LEDs, max 28 W, max 1000 lm, Lebensdauer: 30000 h
Arbeitsflächen- Beleuchtung	Multicolour LEDs, max 28 W, max 1000 lm, Lebensdauer: 30000 h
Fernbedienung	Funk, Mod. 20-02-02
Verkabelung	Ca. 4 m, schwarz
Spannung	200-240 VAC, 50 Hz
Schutzklasse	II
IP 20	für Innenbereich geeignet

Modell	19-01-03
Material/ Farbe	Holz, furniert Weiß, matt
Maße	L 700 x B 700 x H 1100 mm
Gewicht	Ca. 26 kg
EE-Klasse	B
Front- Beleuchtung	Multicolour LEDs, max 14 W, max 500 lm, Lebensdauer: 30000 h
Arbeitsflächen- Beleuchtung	Multicolour LEDs, max 14 W, max 500 lm, Lebensdauer: 30000 h
Fernbedienung	Funk, Mod. 20-02-02
Verkabelung	Ca. 4 m, schwarz
Spannung	200-240 VAC, 50 Hz
Schutzklasse	II
IP 20	für Innenbereich geeignet

Modell	19-01-04
Material/ Farbe	Holz, furniert Weiß, matt
Maße	L 796 x B 1448 x H 1100 mm
Gewicht	Ca. 40 kg
EE-Klasse	B
Front- Beleuchtung	Multicolour LEDs, max 23 W, max 800 lm, Lebensdauer: 30000 h
Arbeitsflächen- Beleuchtung	Multicolour LEDs, max 23 W, max 800 lm, Lebensdauer: 30000 h
Fernbedienung	Funk, Mod. 20-02-02
Verkabelung	Ca. 4 m, schwarz
Spannung	200-240 VAC, 50 Hz
Schutzklasse	II
IP 20	für Innenbereich geeignet

EN EXAMPLE

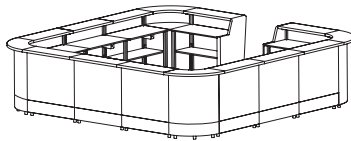

Model	19-01-01
Material/ Colour	Wood with veneer White, satin
Dimensions	L 700 x W 1000 x H 1100 mm
Weight	Approx. 32 kg
EE-Class	B
Illuminated Front	Multicolour LEDs, max 14 W, max 500 lm, life span: 30000 h
Illuminated Work Space	Multicolour LEDs, max 14 W, max 500 lm, life span: 30000 h
Remote control	RF, Mod. 20-02-02
Cable	Approx. 4 m, black
Voltage	200-240 VAC, 50 Hz
Protection Class	II
IP 20	for indoor use

Model	19-01-02
Material/ Colour	Wood with veneer White, satin
Dimensions	L 700 x W 2000 x H 1100 mm
Weight	Approx. 58 kg
EE-Class	B
Illuminated Front	Multicolour LEDs, max 28 W, max 1000 lm, life span: 30000 h
Illuminated Work Space	Multicolour LEDs, max 28 W, max 1000 lm, life span: 30000 h
Remote control	RF, Mod. 20-02-02
Cable	Approx. 4 m, black
Voltage	200-240 VAC, 50 Hz
Protection Class	II
IP 20	for indoor use

Model	19-01-03
Material/ Colour	Wood with veneer White, satin
Dimensions	L 700 x W 700 x H 1100 mm
Weight	Approx. 26 kg
EE-Class	B
Illuminated Front	Multicolour LEDs, max 14 W, max 500 lm, life span: 30000 h
Illuminated Work Space	Multicolour LEDs, max 14 W, max 500 lm, life span: 30000 h
Remote control	RF, Mod. 20-02-02
Cable	Approx. 4 m, black
Voltage	200-240 VAC, 50 Hz
Protection Class	II
IP 20	for indoor use

Model	19-01-04
Material/ Colour	Wood with veneer White, satin
Dimensions	L 796 x W 1448 x H 1100 mm
Weight	Approx. 40 kg
EE-Class	B
Illuminated Front	Multicolour LEDs, max 23 W, max 800 lm, life span: 30000 h
Illuminated Work Space	Multicolour LEDs, max 23 W, max 800 lm, life span: 30000 h
Remote control	RF, Mod. 20-02-02
Cable	Approx. 4 m, black
Voltage	200-240 VAC, 50 Hz
Protection Class	II
IP 20	for indoor use

FR EXEMPLE

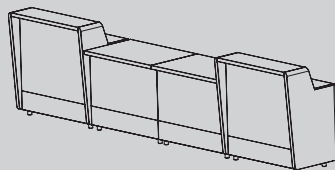

Modèle	19-01-01
Matériaux/ Couleur	Bois avec revêtement Blanc, satin
Dimensions	La 700 x Lo 1000 x H 1100 mm
Poids	Env. 32 kg
Catégorie énergétique	B
Lumière LED Avant	LED multicoloreurs, max 14 W max 500 lm, Durée de vie: 30000h
Lumière LED Espace de Travail	LED multicoloreurs, max 14 W max 500 lm, Durée de vie: 30000h
Commande	Radio contrôle, Mod. 20-02-02
Câblage	Env. 4 m, noir
Tension	200-240 VAC, 50 Hz
Catégorie	II
IP 20	pour utilisation intérieur

Modèle	19-01-02
Matériaux/ Couleur	Bois avec revêtement Blanc, satin
Dimensions	La 700 x Lo 2000 x H 1100 mm
Poids	Env. 58 kg
Catégorie énergétique	B
Lumière LED Avant	LED multicoloreurs, max 28 W max 1000 lm, Durée de vie: 30000h
Lumière LED Espace de Travail	LED multicoloreurs, max 28 W max 1000 lm, Durée de vie: 30000h
Commande	Radio contrôle, Mod. 20-02-02
Câblage	Env. 4 m, noir
Tension	200-240 VAC, 50 Hz
Catégorie	II
IP 20	pour utilisation intérieur

Modèle	19-01-03
Matériaux/ Couleur	Bois avec revêtement Blanc, satin
Dimensions	La 700 x Lo 700 x H 1100 mm
Poids	Env. 26 kg
Catégorie énergétique	B
Lumière LED Avant	LED multicoloreurs, max 14 W max 500 lm, Durée de vie: 30000h
Lumière LED Espace de Travail	LED multicoloreurs, max 14 W max 500 lm, Durée de vie: 30000h
Commande	Radio contrôle, Mod. 20-02-02
Câblage	Env. 4 m, noir
Tension	200-240 VAC, 50 Hz
Catégorie	II
IP 20	pour utilisation intérieur

Modèle	19-01-04
Matériaux/ Couleur	Bois avec revêtement Blanc, satin
Dimensions	La 796 x Lo 1448 x H 1100 mm
Poids	Env. 40 kg
Catégorie énergétique	B
Lumière LED Avant	LED multicoloreurs, max 23 W max 800 lm, Durée de vie: 30000h
Lumière LED Espace de Travail	LED multicoloreurs, max 23 W max 800 lm, Durée de vie: 30000h
Commande	Radio contrôle, Mod. 20-02-02
Câblage	Env. 4 m, noir
Tension	200-240 VAC, 50 Hz
Catégorie	II
IP 20	pour utilisation intérieur

NEW

ENDSTÜCKE L & R ENDCAPS L & R EMBOUT G & D

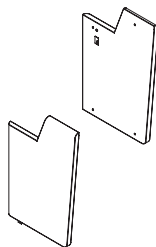

NEW

BUFFET 86

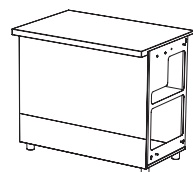

NEW

BUFFET 110

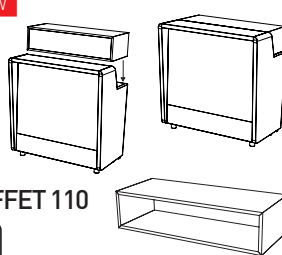

NEW

BAR ZUBEHÖR (OPTIONAL) BAR ACCESSORIES (OPTIONAL) BAR ACCESSOIRES (EN OPTION)

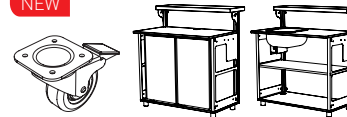

BAR FUNKTIONEN BAR FEATURES BAR FONCTIONS



DE	Modell 19-01-05 ENDSTÜCK LINKS 19-01-06 ENDSTÜCK RECHTS Material/ Farbe MDF, lackiert Weiß, matt Maße L 700 x B 40 x H 1040 mm Gewicht Ca. 10 kg	Modell 19-01-07 Material/ Farbe Holz, furniert Weiß, matt Maße L 660 x B 1000 x H 1100 mm Gewicht Ca. 25 kg EE-Klasse B Front- Beleuchtung Multicolour LEDs, max 14 W, max 500 lm, Lebensdauer: 30000 h Arbeitsflächen- Beleuchtung N/A Fernbedienung Funk, Mod. 20-02-02 Verkabelung Ca. 4 m, schwarz Spannung 200-240 VAC, 50 Hz Schutzklasse II IP 20 für Innenbereich geeignet	Modell 19-01-08 Material/ Farbe Holz, furniert Weiß, matt Maße L 400 x B 1000 x H 250 mm Gewicht Ca. 10 kg	Modell Kühlschrank Maße L 520 x B 430 x H 740 mm Gewicht Ca. 16 kg Volumen 70 liter 1M Modul kann 2 Kühlschränke aufnehmen Modell Waschbecken Maße L 400 x B 500 x H 155 mm Gewicht Ca. 3 kg Modell Rollen mit Bremse Maße Ø 50 mm H 65 mm	Funktionen <ul style="list-style-type: none"> • DUALE MULTICOLOR LED Beleuchtung für Vorderseite und Arbeitsplatz • 4-Kanal Funk-Fernbedienung • Schnelle Verbindung von Modulen • Einfaches Einhängen der Endstücke • Kabelmanagement • Einlegeböden festschraubbar • Justierbare Füße • Rollen mit Bremse (optional) • Kühlschrank (optional) • Waschbecken (optional)
	Model 19-01-05 ENDCAP LEFT 19-01-06 ENDCAP RIGHT Material/ Colour MDF, Coated White, satin Dimensions L 700 x W 40 x H 1040 mm Weight Approx. 10 kg	Model 19-01-07 Material Wood with veneer White, satin Dimensions L 660 x W 1000 x H 1100 mm Weight Approx. 25 kg EE-Class B Illuminated Front Multicolour LEDs, max 14 W, max 500 lm, life span: 30000 h Illuminated Work Space N/A Remote control RF, Mod. 20-02-02 Cable Approx. 4 m, black Voltage 200-240 VAC, 50 Hz Protection Class II IP 20 for indoor use	Model 19-01-08 Material/ Colour MDF, Coated White, satin Dimensions L 400 x W 1000 x H 250 mm Weight Approx. 10 kg	Model Fridge Dimensions L520 x W430 x H740 mm Weight Approx. 16 kg Volume 70 litre 1M Straight Module can fit 2- Fridges Model Sink Dimensions L 400 x W 500 x H 155 mm Weight Approx. 3 kg Model Wheels with brake Dimensions Ø 50 mm H 65 mm	Features <ul style="list-style-type: none"> • DUAL LED LIGHTS for front and work space • 4-channel radio remote control • Fast connection of modules • Easy attachment of endcaps • Cable management • Screw in shelves • Adjustable feet • Wheels with brake (optional) • Fridge (optional) • Sink (optional)
FR	Modèle 19-01-05 EMBOUT GAUCHE 19-01-06 EMBOUT DROIT Matériaux/ Couleur Bois laqué Blanc, satin Dimensions La 700 x Lo 40 x H 1040 mm Poids Env. 10 kg	Modèle 19-01-07 Matériaux/ Couleur Bois avec revêtement Blanc, satin Dimensions La 660 x Lo 990 x H 1100 mm Poids Env. 26 kg Catégorie énergétique B Lumière LED Avant LED multicolore, max 14 W max 500 lm, Durée de vie: 30000h Lumière LED Espace de Travail N/A Commande Radio contrôle, Mod. 20-02-02 Câblage Env. 4 m, noir Tension 200-240 VAC, 50 Hz Catégorie II IP 20 pour utilisation intérieur	Modèle 19-01-08 Matériaux/ Couleur Bois laqué Blanc, satin Dimensions La 400 x Lo 1000 x H 250 mm Poids Env. 10 kg	Modèle Réfrigérateur Dimensions La 520 x Lo 430 x H 740 mm Poids Env. 16 kg Volume 70 litre Module 1M peut accueillir 2 Réfrigérateurs Modèle Lavabo Dimensions La 400 x Lo 500 x H 155 mm Poids Env. 3 kg Modèle Roulettes avec frein Dimensions Ø 50 mm H 65 mm	Fonctions <ul style="list-style-type: none"> • DOUBLE LUMIÈRE pour led avant et espace de travail • 4 canaux télécommande radio • Connexion rapide des modules • Mettre facile des embouts • Management des câbles • Étagères à vis • Pieds réglables • Roulettes avec frein (en option) • Réfrigérateur (en option) • Lavabo (en option)

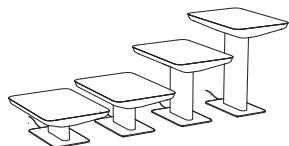

STUDIO 36/45/75/105 INDOOR
STUDIO 36/45/75/105



STUDIO 36/45/75/105
LED PRO



STUDIO 36/45/75/105
LED PRO ACCU



NEW

Inklusiv: 5 mm Glasplatte
Including: 5 mm glass top
Inclus: 5 mm tablette en verre



STUDIO 36/45/75/105
OUTDOOR LED



DE

Modell	STUDIO 36: 16-02-01 / STUDIO 45: 16-02-02 STUDIO 75: 16-02-03 / STUDIO 105: 16-02-04
Material/ Farbe	ABS, PMMA glänzend, weiß transluzent, UV-beständig; Edelstahl gebürstet
Maße	B 70, L 100, H 36/45/75/105 cm
Gewicht	ca. 30,7/32,0/35,4/38,7 kg
EE-Klasse	A++ - E
Leuchtmittel	E27, MAX. 20 W
Verkabelung	ca. 2,5 - 3 m, klar
Spannung	230 V-, 50 Hz
Schutzklasse	II
IP 20	für Innenbereich geeignet
Modell Studio X	Produkt ist nicht leuchtend
STUDIO 36: 16-06-01 / STUDIO 45: 16-06-02	
STUDIO 75: 16-06-03 / STUDIO 105: 16-06-04	

Modell	STUDIO 36: 16-04-01 / STUDIO 45: 16-04-02 STUDIO 75: 16-04-03 / STUDIO 105: 16-04-04
Material/ Farbe	ABS, PMMA glänzend, weiß transluzent, UV-beständig; Edelstahl gebürstet
Maße	B 70, L 100, H 36/45/75/105 cm
Gewicht	ca. 30,7/32,0/35,4/38,7 kg
EE-Klasse	B
Leuchtmittel	Multicolor LEDs, max. 13 W, max 234 lm, Lebensdauer: 35000 Std.
Fernbedienung	Funk
Verkabelung	ca. 2,5 - 3 m, klar
Spannung	200-240 VAC, 50 Hz / MAX 15 W
Schutzklasse	II
IP 20	für Innenbereich geeignet

Modell	STUDIO 36: 16-05-01 / STUDIO 45: 16-05-02 STUDIO 75: 16-05-03 / STUDIO 105: 16-05-04
Material/ Farbe	ABS, PMMA glänzend, weiß transluzent, UV-beständig; Edelstahl gebürstet
Maße	B 70, L 100, H 36/45/75/105 cm
Gewicht	ca. 37,2/38,5/42,0/45,2 kg
EE-Klasse	B
Leuchtmittel	Multicolor LEDs, max. 13 W, max 234 lm, Lebensdauer: 35000 Std.
Fernbedienung	Funk
Akku (SLA)	12 V, 18Ah, Betriebsdauer 25 h
Ladegerät	110-240 V-, 50-60 Hz Vout 12 V, 3 A
Schutzklasse	III (Produkt), II (Ladegerät)
IP 20	für Innenbereich geeignet

Modell	STUDIO 36: 16-03-01 / STUDIO 45: 16-03-02 STUDIO 75: 16-03-04 / STUDIO 105: 16-03-04
Material/ Farbe	ABS, PMMA glänzend, weiß transluzent, UV-beständig; Edelstahl gebürstet
Maße	B 70, L 100, H 36/45/75/105 cm
Gewicht	ca. 30,7/32,0/35,4/38,7 kg
EE-Klasse	A++ - E
Leuchtmittel	E27, MAX. 20 W
Verkabelung	ca. 3,5 - 4 m, schwarz
Spannung	230 V-, 50 Hz
Schutzklasse	II
IP 44	für Aussenbereich geeignet

Modell	STUDIO 36: 16-03-01-LED / STUDIO 45: 16-03-02-LED STUDIO 75: 16-03-04-LED / STUDIO 105: 16-03-04-LED
Material/ Farbe	ABS, PMMA glänzend, weiß transluzent, UV-beständig; Edelstahl gebürstet
Maße	B 70, L 100, H 36/45/75/105 cm
Gewicht	ca. 30,7/32,0/35,4/38,7 kg
EE-Klasse	A++ - E
Leuchtmittel	Multicolor LED Leuchtmittel E27 MAX. 9 W mit Fernbedienung EEK: A, max. 850 lm Lebensdauer: 50.000 Std.
Fernbedienung	Funk
Verkabelung	ca. 3,5 - 4 m, schwarz
Spannung	230 V-, 50 Hz
Schutzklasse	II
IP 44	für Aussenbereich geeignet

EN

Model	STUDIO 36: 16-02-01 / STUDIO 45: 16-02-02 STUDIO 75: 16-02-03 / STUDIO 105: 16-02-04
Material/ Colour	ABS, PMMA glossy, white translucent UV resistant; Stainless steel brushed
Dimensions	W 70, L 100, H 36/45/75/105 cm
Weight	approx. 30,7/32,0/35,4/38,7 kg
EE-Class	A++ - E
Illuminant	E27, MAX. 20 W
Cable	2,5 - 3 m, clear
Voltage	230 V-, 50 Hz
Protection Class	II
IP 20	for indoor use
Model Studio X	Product can not be illuminated
STUDIO 36: 16-06-01 / STUDIO 45: 16-06-02	
STUDIO 75: 16-06-03 / STUDIO 105: 16-06-04	

Model	STUDIO 36: 16-04-01 / STUDIO 45: 16-04-02 STUDIO 75: 16-04-03 / STUDIO 105: 16-04-04
Material/ Colour	ABS, PMMA glossy, white translucent UV resistant; Stainless steel brushed
Dimensions	W 70, L 100, H 36/45/75/105 cm
Weight	approx. 30,7/32,0/35,4/38,7 kg
EE-Class	B
Illuminant	Multicolor LEDs, max. 13 W, max 234 lm, life span: 35000 h
Remote control	RF
Cable	2,5 - 3 m, clear
Voltage	200-240 VAC, 50 Hz / MAX 15 W
Protection Class	II
IP 20	for indoor use

Model	STUDIO 36: 16-05-01 / STUDIO 45: 16-05-02 STUDIO 75: 16-05-03 / STUDIO 105: 16-05-04
Material/ Colour	ABS, PMMA glossy, white translucent UV resistant; Stainless steel brushed
Dimensions	W 70, L 100, H 36/45/75/105 cm
Weight	approx. 37,2/38,5/42,0/45,2 kg
EE-Class	B
Illuminant	Multicolor LEDs, max. 13 W max 234lm, life span: 35000 h
Remote control	RF
Battery (SLA)	12 V, 18Ah, operating time 25 h
Charger	110-240 V-, 50-60 Hz Vout 12 V, 3 A
Protection Class	III (Product), II (Charger)
IP 20	for indoor use

Model	STUDIO 36: 16-03-01 / STUDIO 45: 16-03-02 STUDIO 75: 16-03-04 / STUDIO 105: 16-03-04
Material/ Colour	ABS, PMMA glossy, white translucent UV resistant; Stainless steel brushed
Dimensions	W 70, L 100, H 36/45/75/105 cm
Weight	approx. 30,7/32,0/35,4/38,7 kg
EE-Class	A++ - E
Illuminant	E27, MAX. 20 W
Cable	3,5 - 4 m, black
Voltage	230 V-, 50 Hz
Protection Class	II
IP 44	for outdoor use

Model	STUDIO 36: 16-03-01-LED / STUDIO 45: 16-03-02-LED STUDIO 75: 16-03-04-LED / STUDIO 105: 16-03-04-LED
Material/ Colour	ABS, PMMA glossy, white translucent UV resistant; Stainless steel brushed
Dimensions	W 70, L 100, H 36/45/75/105 cm
Weight	approx. 30,7/32,0/35,4/38,7 kg
EE-Class	A++ - E
Illuminant	LED multicolor light bulb E27, MAX. 9 W with remote control EEK: A, max. 850 lm Life span: 50.000 h
Remote Control	RF
Cable	3,5 - 4 m, black
Voltage	230 V-, 50 Hz
Protection Class	II
IP 44	for outdoor use

FR

Modèle	STUDIO 36: 16-02-01 / STUDIO 45: 16-02-02 STUDIO 75: 16-02-03 / STUDIO 105: 16-02-04
Matériaux/ Couleur	ABS, PMMA brillant, blanc, translucide résistant aux rayons UV; acier inoxydable brossé
Dimensions	La 70, Lo 100, H 36/45/75/105 cm
Poids	env. 30,7/32,0/35,4/38,7 kg
Classe énergétique	A++ - E
Ampoule	E27, MAX. 20 W
Câblage	env. 2,5 - 3 m, transparent
Tension	230 V-, 50 Hz
Catégorie	II
IP 20	pour utilisation intérieur
Modèle Studio X	Le produit n'a pas de lumière
STUDIO 36: 16-06-01 / STUDIO 45: 16-06-02	
STUDIO 75: 16-06-03 / STUDIO 105: 16-06-04	

Modèle	STUDIO 36: 16-04-01 / STUDIO 45: 16-04-02 STUDIO 75: 16-04-03 / STUDIO 105: 16-04-04
Matériaux/ Couleur	ABS, PMMA brillant, blanc, translucide résistant aux rayons UV; acier inoxydable brossé
Dimensions	La 70, Lo 100, H 36/45/75/105 cm
Poids	env. 30,7/32,0/35,4/38,7 kg
Catégorie énergétique	
Ampoule	LED multicolore, max 13 W max 234 lm, Durée de vie: 35000h
Commande	Radio contrôle
Câblage	env. 2,5 - 3 m, transparent
Tension	200-240 VAC, 50 Hz / MAX 15 W
Catégorie	II
IP 20	pour utilisation intérieur

Modèle	STUDIO 36: 16-05-01 / STUDIO 45: 16-05-02 STUDIO 75: 16-05-03 / STUDIO 105: 16-05-04
Matériaux/ Couleur	ABS, PMMA brillant, blanc, translucide résistant aux rayons UV; acier inoxydable brossé
Dimensions	La 70, Lo 100, H 36/45/75/105 cm
Poids	env. 37,2/38,5/42,0/45,2 kg
Catégorie énergétique	B
Ampoule	LED multicolore, max 13 W max 234 lm, Durée de vie: 35000h
Commande	IR (adaptation radio contrôle possible)
Batterie (SLA)	12 V, 18Ah, operating time 25 h
Chargeur	110-240 V-, 50-60 Hz Vout 12 V, 3 A
Catégorie	III (Produit), II (Chargeur)
IP 20	pour utilisation intérieur

Modèle	STUDIO 36: 16-03-01 / STUDIO 45: 16-03-02 STUDIO 75: 16-03-04 / STUDIO 105: 16-03-04
Matériaux/ Couleur	ABS, PMMA brillant, blanc, translucide résistant aux rayons UV; acier inoxydable brossé
Dimensions	La 70, Lo 100, H 36/45/75/105 cm
Poids	env. 30,7/32,0/35,4/38,7 kg
Classe énergétique	A++ - E
Ampoule	E27, MAX. 20 W
Câblage	env. 3,5 - 4 m, noir
Tension	230 V-, 50 Hz
Catégorie	II
IP 44	pour utilisation extérieure

Modèle	STUDIO 36: 16-03-01-LED / STUDIO 45: 16-03-02-LED STUDIO 75: 16-03-04-LED / STUDIO 105: 16-03-04-LED
Matériaux/ Couleur	ABS, PMMA brillant, blanc, translucide résistant aux rayons UV; acier inoxydable brossé
Dimensions	La 70, Lo 100, H 36/45/75/105 cm
Poids	env. 30,7/32,0/35,4/38,7 kg
Classe énergétique	A++ - E
Ampoule	Ampoule LED multicolore E27, MAX. 9 W avec télécommande CE: A, max. 850 lm Durée de vie: 50.000 h
Télécommande	Radio contrôle
Câblage	env. 3,5 - 4 m, noir
Tension	230 V-, 50 Hz
Catégorie	II
IP 44	pour utilisation extérieure

AVAILABLE IN
20+ COLOURS!

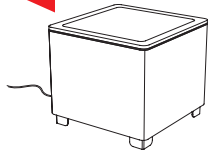

ORA X



ORA LED



ORA LED ACCU



ORA LED PRO ACCU



Andere Farben auf Anfrage möglich/
Other colours available on request/
Autres couleurs disponibles sur demande

Inklusiv: 6 mm Glasplatte
Including: 6 mm glass top
Inclus: 6 mm tablette en verre

Modell	Weiss: 28-05-01, Schwarz: 28-25-01, Walnuss: 28-15-01
Material	MDF, lackiert/ Walnuss furniert
Farbe	Weiß/Schwarz seidenmatt, Walnuss
Maße	ca. L 60 x B 60 x H 45 cm
Gewicht	ca. 25/ 28 kg
Leuchtmittel	Produkt ist nicht leuchtend
Bereich	für Innenbereich geeignet

Modell	Weiss: 28-01-01, Schwarz: 28-21-01, Walnuss 28-10-01
Material	MDF, lackiert/ Walnuss furniert
Farbe	Weiß/Schwarz seidenmatt, Walnuss
Maße	ca. L 60 x B 60 x H 45 cm
Gewicht	ca. 25/ 28 kg
EE-Klasse	A++ - E

Leuchtmittel	Multicolor LED Leuchtmittel E27, max. 9 W mit Fernbedienung EEK: A, max. 850 lm Lebensdauer: 50.000 Std.
Fernbedienung	Funk
Verkabelung	ca. 3,7 m mit Fußschalter, klar
Spannung	230 V~, 50 Hz
Schutzklasse	II
Bereich	für Innenbereich geeignet

Modell	Weiss: 28-03-01, Schwarz: 28-23-01, Walnuss 28-13-01
Material	MDF, lackiert/ Walnuss furniert
Farbe	Weiß/Schwarz seidenmatt, Walnuss
Maße	ca. L 60 x B 60 x H 45 cm
Gewicht	ca. 25/ 28 kg
EE-Klasse	B

Leuchtmittel	Multicolor LEDs, max. 4 W, max 136 lm, Lebensdauer: 30000 Std.
Fernbedienung	IR
Akku (Li-Ion)	3.7 V / 2 x 2200 mAh Betriebsdauer 10 h
Ladegerät	100-240VAC, 50/60Hz, Vout 7.5V/0,6A
Schutzklasse	III (Produkt), II (Ladegerät)
Bereich	für Innenbereich geeignet

Modell	Weiss: 28-04-01, Schwarz 28-24-01, Walnuss 28-14-01
Material	MDF, lackiert/ Walnuss furniert
Farbe	Weiß/Schwarz seidenmatt, Walnuss
Maße	ca. L 60 x B 60 x H 45 cm
Gewicht	ca. 28/ 31 kg
EE-Klasse	B

Leuchtmittel	Multicolor LEDs, max. 9 W, max 234 lm, Lebensdauer: 30000 Std.
Fernbedienung	Funk
Akku (SLA)	12 V, 7Ah, Betriebsdauer 15 h
Ladegerät	110-240V~, 50-60 Hz Vout 12V, 3A
Schutzklasse	III (Produkt), II (Ladegerät)
Bereich	für Innenbereich geeignet

Model	White: 28-05-01 Black: 28-25-01 Walnut: 28-15-01
Material	MDF, painted/ Walnut veneered
Colour	Satin white/black, Walnut
Dimensions	approx. L 60 x W 60 x H 45 cm
Weight	approx. 25/ 28 kg
Illuminant	Product can not be illuminated
Use	for indoor use

Model	White: 28-01-01, Black: 28-21-01, Walnut: 28-10-01
Material	MDF, painted/ Walnut veneered
Colour	Satin white/black, Walnut
Dimensions	approx. L 60 x W 60 x H 45 cm
Weight	approx. 25/ 28 kg
EE-Class	A++ - E
Illuminant	LED multicolor light bulb E27, max. 9 W with remote control EEC: A, max. 850 lm Life span: 50.000 h
Remote Control	RF
Cable	approx. 3.7 m cable, clear
Voltage	230 V~, 50Hz
Protection Class	II
Use	for indoor use

Model	White: 28-03-01, Black: 28-23-01, Walnut: 28-13-01
Material	MDF, painted/ Walnut veneered
Colour	Satin white/black, Walnut
Dimensions	approx. L 60 x W 60 x H 45 cm
Weight	approx. 25/ 28 kg
EE-Class	B
Illuminant	Multicolor LEDs, max. 4 W, max 136 lm, life span: 30.000 h
Remote control	IR
Battery (Li-Ion)	3.7 V / 2 x 2200 mAh operating time 10 h
Charger	100-240VAC, 50/60Hz, Vout 7.5V/0,6A
Protection Class	III (Product), II (Charger)
Use	for indoor use

Model	White: 28-04-01, Black: 28-24-01, Walnut: 28-14-01
Material	MDF, painted/ Walnut veneered
Colour	Satin white/black, Walnut
Dimensions	approx. L 60 x W 60 x H 45 cm
Weight	approx. 28/ 31 kg
EE-Class	B
Illuminant	Multicolor LEDs, max. 9 W max 234lm, life span: 30000 h
Remote control	RF
Battery (SLA)	12 V, 7Ah, operating time 15 h
Charger	110-240 V~, 50-60 Hz Vout 12 V, 3 A
Protection Class	III (Product), II (Charger)
Use	for indoor use

Modèle	Blanche: 28-05-01 Noir: 28-25-01 Noyer: 28-15-01
Matériaux	MDF, laqué/ noyer plaqué
Couleur	Blanc/Noirsatin, Noyer
Dimensions	env. La 60 x Lo 60 x H 45 cm
Poids	env. 25/ 28 kg
Ampoule	Le produit n'a pas de lumière
Utilisation	pour utilisation intérieur

Modèle	Blanche: 28-01-01, Noir: 28-21-01, Noyer 28-10-01
Matériaux	MDF, laqué/ noyer plaqué
Couleur	Blanc/Noir satin, Noyer
Dimensions	env. La 60 x Lo 60 x H 45 cm
Poids	env. 25/ 28 kg
Classe énergétique	A++ - E
Ampoule	Ampoule LED multicolore E27, max. 9 W avec télécommande CÉ: A, max. 850 lm Durée de vie: 50.000 h
Télécommande	Radio contrôle
Câblage	env. 3,7 m transparent
Tension	230 V~, 50 Hz
Catégorie	II
Utilisation	pour utilisation intérieur

Modèle	Blanche: 28-03-01, Noir: 28-23-01, Noyer 28-13-01
Matériaux	MDF, laqué/ noyer plaqué
Couleur	Blanc/Noirsatin, Noyer
Dimensions	env. La 60 x Lo 60 x H 45 cm
Poids	env. 25/ 28 kg
Classe énergétique	B
Ampoule	LED multicolore, max 4 W max 136 lm, Durée de vie: 30000h
Commande	IR
Batterie (Li-Ion)	3.7 V / 2 x 2200 mAh autonomie: 10 h
Chargeur	100-240VAC, 50/60Hz, Vout 7.5V/0,6A
Catégorie	III (Produit), II (Chargeur)
Utilisation	pour utilisation intérieur

Modèle	Blanche: 28-04-01, Noir: 28-24-01, Noyer 28-14-01
Matériaux	MDF, laqué/ noyer plaqué
Couleur	Blanc/Noirsatin, Noyer
Dimensions	env. La 60 x Lo 60 x H 45 cm
Poids	env. 28/ 31 kg
Classe énergétique	B
Ampoule	LED multicolore, max 9 W max 234 lm, Durée de vie: 30000h
Commande	Radio contrôle
Batterie (SLA)	12 V, 7Ah, autonomie: 15 h
Chargeur	110-240 V~, 50-60 Hz Vout 12 V, 3 A
Catégorie	III (Produit), II (Chargeur)
Utilisation	pour utilisation intérieur

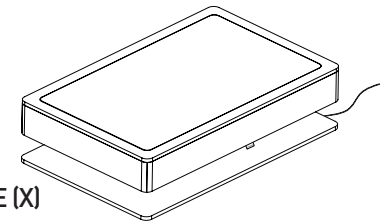

ORA HOME (X)



Modell	28-17-01
Material	Holz, lackiert
Farbe	Weiß seidenmatt
Maße	L 1100 x W 700 x H 290 mm
Gewicht	ca. 26.3 kg
Leuchtmittel	Produkt ist nicht leuchtend
Bereich	für Innenbereich geeignet

Model	28-17-01
Material	MDF, painted/ Walnut veneered
Colour	White, satin
Dimensions	L 1100 x W 700 x H 290 mm
Weight	approx. 26.3 kg
Illuminant	Product can not be illuminated
Use	for indoor use

Modèle	28-17-01
Matériaux	Bois, laqué
Couleur	Blancsatin
Dimensions	L 1100 x W 700 x H 290 mm
Poids	env. 26.3 kg
Ampoule	Le produit n'a pas de lumière
Utilisation	pour utilisation intérieur

Inklusiv: 5 mm Glasplatte, tranzluzent
Including: 5 mm glass top, translucent
Inclus: 5 mm tablette en verre, translucide



ORA HOME LED PRO

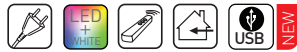

DE	Modell	28-16-01
	Material	MDF, lackiert
	Farbe	Weiß, seidenmatt
	Maße	L 1100 x W 700 x H 290 mm
	Gewicht	ca. 28,2 kg
	EE-Klasse	A
	Leuchtmittel	Multicolor LEDs, max 24 W Max. 829 lm Lebensdauer: 30000 Std. Warmweiß licht 2600-2800K
	USB-Steckdose	2 x 5 V DC/ MAX. 1 A
	Fernbedienung	Funk
	Verkabelung	Ca. 3 m, rot
	Spannung	200-240 VAC, 50 Hz
	Schutzklasse	II
	IP 20	für Innenbereich geeignet

EN	Model	28-16-01
	Material	Wood, spray painted
	Colour	White, satin
	Dimensions	L 1100 x W 700 x H 290 mm
	Weight	approx. 28,2 kg
	EE-Class	A
	Illuminant	Multicolor LEDs, max 24 W Max. 829 lm Life span: 30000 h Warm white light 2600-2800K
	USB Ports	2 x 5 V DC/ MAX. 1 A
	Remote Control	RF
	Cable	approx. 3 m, red
	Voltage	200-240 VAC, 50 Hz
	Protection Class	II
	IP 20	for indoor use

FR	Modèle	28-16-01
	Matériaux	Bois, laqué
	Couleur	Blanc satin
	Dimensions	(La) 1100 x (Lo) 700 x (H) 290 mm
	Poids	env. 28,2 kg
	Classe énergétique	A
	Ampoule	LED multicolours, max 24 W Max. 829 lm Durée de vie: 30000 h Lumière Blanc Chaud 2600-2800K
	Prise USB	2 x 5 V DC/ MAX. 1 A
	Télécommande	Radio contrôle
	Câblage	env. 3 m, rouge
	Tension	200-240 VAC, 50 Hz
	Catégorie	II
	IP 20	pour utilisation intérieur



LOUNGE 45/55/75/105 INDOOR



Modell	LOUNGE 45: 07-06-04 / LOUNGE 55: 07-06-01 LOUNGE 75: 07-06-02 / LOUNGE 105: 07-06-03
Material/	ABS, PMMA glänzend, weiß transluzent, UV-beständig; Aluminium gebürstet
Maße	Ø ca. 84, H 45/55/75/105 cm
Gewicht	ca. 24,4/24,9/25,1/31,5 kg
EE-Klasse	A++ - E
Leuchtmittel	1x max. 42 W E27
Verkabelung	ca. 2,5 - 3 m, klar
Spannung	230 V~, 50 Hz
Schutzklasse	II
IP 20	für Innenbereich geeignet

Model	LOUNGE 45: 07-06-04 / LOUNGE 55: 07-06-01 LOUNGE 75: 07-06-02 / LOUNGE 105: 07-06-03
Material/	ABS, PMMA glossy, white translucent UV resistant; aluminium brushed
Dimensions	Ø approx. 84, H 45/55/75/105 cm
Weight	approx. 24,4/24,9/25,1/31,5 kg
EE-Class	A++ - E
Illuminant	1x max. 42 W E27
Cable	2,5 - 3 m, clear
Voltage	230 V~, 50 Hz
Protection Class	II
IP 20	for indoor use

Modèle	LOUNGE 45: 07-06-04 / LOUNGE 55: 07-06-01 LOUNGE 75: 07-06-02 / LOUNGE 105: 07-06-03
Matériaux/	ABS, PMMA brillant, blanc, translucide ré- Coulleur sistant aux rayons UV; Aluminium brossé
Dimensions	Ø env. 84, H 45/55/75/105 cm
Poids	env. 24,4/24,9/25,1/31,5 kg
Classe énergétique	A++ - E
Ampoule	1 x max. 42 W E27
Câblage	env. 2,5 - 3 m, transparent
Tension	230 V~, 50 Hz
Catégorie	II
IP 20	pour utilisation intérieur

LOUNGE 45/55/75/105 LED PRO



Modell	LOUNGE 45: 07-08-04 / LOUNGE 55: 07-08-01 LOUNGE 75: 07-08-02 / LOUNGE 105: 07-08-03
Material/	ABS, PMMA glänzend, weiß transluzent, UV-beständig; Aluminium gebürstet
Maße	Ø ca. 84, H 45/55/75/105 cm
Gewicht	ca. 24,4/24,9/25,1/31,5 kg
EE-Klasse	A++ - E
Leuchtmittel	LED multicolor Leuchtmittel E27, max. 9 W mit Fernbedienung EEK: A, max. 850 lm Lebensdauer: 50.000 std.
Fernbedienung	Funk
Verkabelung	ca. 2,5 - 3 m, klar
Spannung	230 V~, 50 Hz
Schutzklasse	II
IP 20	für Innenbereich geeignet

Model	LOUNGE 45: 07-06-04 -LED/ LOUNGE 55: 07-06-01-LED LOUNGE 75: 07-06-02-LED / LOUNGE 105: 07-06-03-LED
Material/	ABS, PMMA glossy, white translucent UV resistant; aluminium brushed
Dimensions	Ø approx. 84, H 45/55/75/105 cm
Weight	approx. 24,4/24,9/25,1/31,5 kg
EE-Class	A++ - E
Illuminant	LED multicolour light bulb E27, max. 9 W with remote control EEC: A, max. 850 lm Life span: 50.000 h
Remote control	RF
Cable	2,5 - 3 m, clear
Voltage	230 V~, 50 Hz
Protection Class	II
IP 20	for indoor use

Modèle	LOUNGE 45: 07-06-04 -LED/ LOUNGE 55: 07-06-01-LED LOUNGE 75: 07-06-02-LED / LOUNGE 105: 07-06-03-LED
Matériaux/	ABS, PMMA brillant, blanc, translucide ré- Coulleur sistant aux rayons UV; Aluminium brossé
Dimensions	Ø env. 84, H 45/55/75/105 cm
Poids	env. 24,4/24,9/25,1/31,5 kg
Classe énergétique	A++ - E
Ampoule	LED multicolours E27 max. 9 W avec télé- commande/ CÉ: A, max. 850 lm/ Durée de vie: 50.000 h
Télécommande	Radio contrôle
Câblage	env. 2,5 - 3 m, transparent
Tension	230 V~, 50 Hz
Catégorie/ IP 20	II/ pour utilisation intérieur



LOUNGE 45/55/75/105 LED PRO ACCU



Modell	LOUNGE 45: 07-09-04 / LOUNGE 55: 07-09-01 LOUNGE 75: 07-09-02 / LOUNGE 105: 07-09-03
Material/	ABS, PMMA glänzend, weiß transluzent, UV-beständig; Aluminium gebürstet
Maße	Ø ca. 84, H 45/55/75/105 cm
Gewicht	ca. 29,1/29,6/29,8/36,2 kg
EE-Klasse	B
Leuchtmittel	Multicolor LEDs, max 13W, max 234 lm, Lebensdauer: 35000 Std.
Fernbedienung	Funk
Akku (SLA)	12V, 12Ah, Betriebsdauer 16 h
Ladegerät	110-240 V~, 50-60 Hz Vout 12V, 3 A
Schutzklasse	III (Produkt), II (Ladegerät)
IP 20	für Innenbereich geeignet

Model	LOUNGE 45: 07-09-04 / LOUNGE 55: 07-09-01 LOUNGE 75: 07-09-02 / LOUNGE 105: 07-09-03
Material/	ABS, PMMA glossy, white translucent UV resistant; aluminium brushed
Dimensions	Ø approx. 84, H 45/55/75/105 cm
Weight	approx. 29,1/29,6/29,8/36,2 kg
EE-Class	B
Illuminant	Multicolor LEDs, max. 13 W max 234 lm, life span: 35000 h
Remote control	RF
Battery (SLA)	12V, 12Ah, operating time 16 h
Charger	110-240 V~, 50-60 Hz Vout 12V, 3 A
Protection Class	III (Product), II (Charger)
IP 20	for indoor use

Modèle	LOUNGE 45: 07-09-04 / LOUNGE 55: 07-09-01 LOUNGE 75: 07-09-02 / LOUNGE 105: 07-09-03
Matériaux/	ABS, PMMA brillant, blanc, translucide ré- Coulleur sistant aux rayons UV; Aluminium brossé
Dimensions	Ø env. 84, H 45/55/75/105 cm
Poids	env. 29,1/29,6/29,8/36,2 kg
Classe énergétique	B
Ampoule	LED multicolours, max 13 W max 174 lm, Durée de vie: 35000h
Commande	Radio contrôle
Batterie (SLA)	12V, 12Ah, autonomie 16 h
Chargeur	110-240V~, 50-60 Hz Vout 12V, 3 A
Catégorie	III (Produit), II (Chargeur)
IP 20	pour utilisation intérieur

LOUNGE 45/55/75/105 OUTDOOR



Modell	LOUNGE 45: 07-07-04 / LOUNGE 55: 07-07-01 LOUNGE 75: 07-07-02 / LOUNGE 105: 07-07-03
Material/	ABS, PMMA glänzend, weiß transluzent, UV-beständig; Aluminium gebürstet
Maße	Ø ca. 84, H 45/55/75/105 cm
Gewicht	ca. 24,4/24,9/25,1/31,5 kg
EE-Klasse	A++ - E
Leuchtmittel	1x max. 42 W E27
Verkabelung	ca. 3,5 - 4 m, schwarz
Spannung	230 V~, 50 Hz
Schutzklasse	II
IP 44	für Aussenbereich geeignet

Model	LOUNGE 45: 07-07-04 / LOUNGE 55: 07-07-01 LOUNGE 75: 07-07-02 / LOUNGE 105: 07-07-03
Material/	ABS, PMMA glossy, white translucent UV resistant; aluminium brushed
Dimensions	Ø approx. 84, H 45/55/75/105 cm
Weight	approx. 24,4/24,9/25,1/31,5 kg
EE-Class	A++ - E
Illuminant	1x max. 42 W E27
Cable	3,5 - 4 m, black
Voltage	230 V~, 50 Hz
Protection Class	II
IP 44	for outdoor use

NEW

Inklusiv: 5 mm Glasplatte
Including: 5 mm glass top
Inclus: 5 mm tablette en verre



LOUNGE 45/55/75/105 LED PRO OUTDOOR



Modell	LOUNGE 45: 07-08-06 / LOUNGE 55: 07-08-07 LOUNGE 75: 07-08-08 / LOUNGE 105: 07-08-05
Material/	ABS, PMMA glänzend, weiß transluzent, Farbe UV-beständig; Aluminium gebürstet
Maße	Ø ca. 84, H 45/55/75/105 cm
Gewicht	ca. 24,4/24,9/25,1/31,5 kg
EE-Klasse	A++ - E
Leuchtmittel	Multicolor LED Leuchtmittel E27 max. 9 W mit Fernbedienung EEK: A, max. 850 lm Lebensdauer: 50.000 Std.
Fernbedienung	Funk
Verkabelung	ca. 5 m Kabel, schwarz
Schutzklasse	230 V-, 50 Hz
Spannung	II
IP 44	für Aussenbereich geeignet
Model	LOUNGE 45: 07-08-06 / LOUNGE 55: 07-08-07 LOUNGE 75: 07-08-08 / LOUNGE 105: 07-08-05
Material/	ABS, PMMA glossy, white translucent Colour UV resistant; aluminium brushed
Dimensions	Ø approx. 84, H 45/55/75/105 cm
Weight	approx. 24,4/24,9/25,1/31,5 kg
EE-Class	A++ - E
Illuminant	LED multicolor light bulb E27, max. 9 W with remote control EEC: A, max. 850 lm Life span: 50.000 h
Remote Control	RF
Cable	approx. 5 m cable, black
Voltage	230 V-, 50 Hz
Protection Class	II
IP 44	for outdoor use

Modèle	LOUNGE 45: 07-08-06 / LOUNGE 55: 07-08-07 LOUNGE 75: 07-08-08 / LOUNGE 105: 07-08-05
Matériaux/	ABS, PMMA brillant, blanc, translucide ré- Couleur sistant aux rayons UV; Aluminium brossé
Dimensions	Ø env. 84, H 45/55/75/105 cm
Poids	env. 24,4/24,9/25,1/31,5 kg
Classe énergétique	A++ - E
Ampoule	LED multicoloreurs E27 max. 9 W avec télé- commande/ CÉ: A, max. 850 lm/ Durée de vie: 50.000 h
Télécommande	Radio contrôle
Câblage	env. 5 m, noir
Tension	230 V-, 50 Hz
Catégorie	II
IP 44	pour utilisation extérieure

LOUNGE 45/55/75/105 LOUNGE LED ACCU OUTDOOR



Modell	LOUNGE 45: 07-11-04 / LOUNGE 55: 07-11-01 LOUNGE 75: 07-11-02 / LOUNGE 105: 07-11-03
Material/	ABS, PMMA glänzend, weiß transluzent, Farbe UV-beständig; Aluminium gebürstet
Maße	Ø ca. 84, H 45/55/75/105 cm
Gewicht	Ca. 24,4/ 24,9/ 25,1/ 25,5 kg
EE-Klasse	B
Leuchtmittel	Multicolor LEDs, max. 4 W, max 136 lm, Lebensdauer: 30000 Std.
Fernbedienung	IR
Akku (Li-Ion)	3.7 V / 2 x 2000 mAh Betriebsdauer 10 h
Ladegerät	100-240 VAC, 50/60 Hz, Vout: 7.5V/ 0,6 A
Schutzklasse	III (Produkt), II (Ladegerät)
IP 22	für Aussenbereich geeignet
Model	LOUNGE 45: 07-11-04 / LOUNGE 55: 07-11-01 LOUNGE 75: 07-11-02 / LOUNGE 105: 07-11-03
Material/	ABS, PMMA glossy, white translucent Colour UV resistant; aluminium brushed
Dimensions	Ø ca. 84, H 45/55/75/105 cm
Weight	Ca. 24,4/ 24,9/ 25,1/ 25,5 kg
EE-Class	B
Illuminant	Multicolor LEDs, max. 4 W, max 136 lm, life span: 30.000 h
Remote control	IR
Battery (Li-Ion)	3.7 V / 2 x 2000 mAh operating time 10 h
Charger	100-240 VAC, 50/60 Hz, Vout: 7.5V/ 0,6 A
Protection Class	III (Product), II (Charger)
IP 22	for outdoor use

Modèle	LOUNGE 45: 07-11-04 / LOUNGE 55: 07-11-01 LOUNGE 75: 07-11-02 / LOUNGE 105: 07-11-03
Matériaux/	ABS, PMMA brillant, blanc, translucide ré- Couleur sistant aux rayons UV; Aluminium brossé
Dimensions	Ø env. 84, H 45/55/75/105 cm
Poids	env. 24,4/24,9/25,1/25,5 kg
Classe énergétique	B
Ampoule	LED multicoloreurs, max 4 W max 136 lm, Durée de vie: 30000h
Commande	IR
Batterie	3.7 V / 2 x 2200 mAh (Li-Ion) autonomie: 10 h
Chargeur	100-240 VAC, 50/60 Hz, Vout: 7.5V/ 0,6 A
Catégorie	III (Objet), II (Chargeur)
IP 22w9	pour utilisation extérieure



LOUNGE M 45/55/75/105 INDOOR/ LOUNGE MX 45/55/75/105



Modell	LOUNGE M 45: 27-02-45 / LOUNGE M 55: 27-02-55 LOUNGE M 75: 27-02-75 / LOUNGE M 105: 27-02-105
Material/	ABS, PMMA glänzend, weiß transluzent, Farbe UV-beständig; Aluminium gebürstet
Maße	Ø ca. 60, H 45/55/75/105 cm
EE-Klasse	A++ - E
Gewicht	ca. 15,1/15,3/15,7/20,0 kg
Leuchtmittel	1x max. 28 W E27
Verkabelung	ca. 3,4/3,3/3,1/2,8 m, klar
Spannung	230 V-, 50 Hz
Schutzklasse	II
IP 20	für Innenbereich geeignet
Lounge MX	(Produkt ist nicht leuchtend)
LOUNGE M 45: 27-01-45 / LOUNGE M 55: 27-01-55 LOUNGE M 75: 27-01-75 / LOUNGE M 105: 27-01-105	
Model	LOUNGE M 45: 27-02-45 / LOUNGE M 55: 27-02-55 LOUNGE M 75: 27-02-75 / LOUNGE M 105: 27-02-105
Material/	ABS, PMMA glossy, white translucent Colour UV resistant; aluminium brushed
Dimensions	Ø approx. 60, H 45/55/75/105 cm
EE-Klasse	A++ - E
Weight	approx. 15,1/15,3/15,7/20,0 kg
Illuminant	1x max. 28 W E27
Cable	approx. 3,4/3,3/3,1/2,8 m, clear
Voltage	230 V-, 50 Hz
Protection Class	II
IP 20	for indoor use
Lounge MX	(Product can not be illuminated)
LOUNGE M 45: 27-01-45 / LOUNGE M 55: 27-01-55 LOUNGE M 75: 27-01-75 / LOUNGE M 105: 27-01-105	

Modèle	LOUNGE M 45: 27-01-45 / LOUNGE M 55: 27-01-55 LOUNGE M 75: 27-01-75 / LOUNGE M 105: 27-01-105
Matériaux/	ABS, PMMA brillant, blanc, translucide ré- Couleur sistant aux rayons UV; Aluminium brossé
Dimensions	Ø env. 60, H 45/55/75/105 cm
Poids	env. 15,1/15,3/15,7/20,0 kg
Classe énergétique	A++ - E
Ampoule	1x max. 28 W E27
Câblage	env. 3,4/3,3/3,1/2,8 m, transparent
Tension	230 V-, 50 Hz
Catégorie	II / IP 20 pour utilisation intérieur
Lounge MX	(Le produit n'a pas de lumière)
LOUNGE M 45: 27-01-45 / LOUNGE M 55: 27-01-55 LOUNGE M 75: 27-01-75 / LOUNGE M 105: 27-01-105	

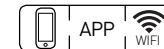

LOUNGE M 45/55/75/105 INDOOR LED



Modell	LOUNGE M 45: 27-02-45 - LED / LOUNGE M 55: 27-02-55 - LED / LOUNGE M 75: 27-02-75 - LED / LOUNGE M 105: 27-02-105 - LED
Material/	ABS, PMMA glänzend, weiß transluzent, Farbe UV-beständig; Aluminium gebürstet
Maße	Ø ca. 60, H 45/55/75/105 cm
EE-Klasse	A++ - E
Gewicht	ca. 15,1/15,3/15,7/20,0 kg
Leuchtmittel	LED multicolor Leuchtmittel E27, max. 9 W mit Fernbedienung EEK: A, max. 850 lm Lebensdauer: 50.000 std.
Fernbedienung	Funk
Verkabelung	ca. 3,4/3,3/3,1/2,8 m, klar
Spannung	230 V-, 50 Hz
Schutzklasse	II
IP 20	für Innenbereich geeignet
Model	LOUNGE M 45: 27-02-45 - LED / LOUNGE M 55: 27-02-55 - LED / LOUNGE M 75: 27-02-75 - LED / LOUNGE M 105: 27-02-105 - LED
Material/	ABS, PMMA glossy, white translucent Colour UV resistant; aluminium brushed
Dimensions	Ø approx. 60, H 45/55/75/105 cm
EE-Klasse	A++ - E
Weight	approx. 15,1/15,3/15,7/20,0 kg
Illuminant	LED multicolour light bulb E27, max. 9 W with remote control EEC: A, max. 850 lm Life span: 50.000 h
Remote Control	RF
Cable	approx. 3,4/3,3/3,1/2,8 m, clear
Voltage	230 V-, 50 Hz
Protection Class	II
IP 20	for indoor use

Modèle	LOUNGE M 45: 27-02-45 - LED / LOUNGE M 55: 27-02-55 - LED / LOUNGE M 75: 27-02-75 - LED / LOUNGE M 105: 27-02-105 - LED
Matériaux/	ABS, PMMA brillant, blanc, translucide ré- Couleur sistant aux rayons UV; Aluminium brossé
Dimensions	Ø env. 60, H 45/55/75/105 cm
Poids	env. 15,1/15,3/15,7/20,0 kg
Classe énergétique	A++ - E
Ampoule	LED multicoloreurs E27 max. 9 W avec télé- commande/ CÉ: A, max. 850 lm/ Durée de vie: 50.000 h
Commande	Radio contrôle
Câblage	env. 3,4/3,3/3,1/2,8 m, transparent
Tension	230 V-, 50 Hz
Catégorie	II
IP 20	pour utilisation intérieur



LOUNGE M 45/55/75/105 LED PRO ACCU



Modell	LOUNGE M 45: 27-06-45 / LOUNGE M 55: 27-06-55 LOUNGE M 75: 27-06-75 / LOUNGE M 105: 27-06-105
Material/	ABS, PMMA glänzend, weiß transluzent, Farbe UV-beständig; Aluminium gebürstet
Maße	Ø ca. 60, H 45/55/75/105 cm
Gewicht	ca. 24 Kg
EE-Klasse	B
Leuchtmittel	Multicolor LEDs, max. 9 W, max 234 lm, Lebensdauer: 30000 Std.
Fernbedienung	Funk
Akku (SLA)	12V, 7Ah, Betriebsdauer 15 h
Ladegerät	100-240 VAC, 50/60 Hz, Vout: 5V, 1 A
Schutzklasse	III (Produkt), II (Ladegerät)
IP 20	für Innenbereich geeignet
Model	LOUNGE M 45: 27-03-45 / LOUNGE M 55: 27-03-55 LOUNGE M 75: 27-03-75 / LOUNGE M 105: 27-03-105
Material/	ABS, PMMA glossy, white translucent Colour UV resistant; aluminium brushed
Dimensions	Ø approx. 60, H 45/55/75/105 cm
Weight	approx. 24 kg
EE-Class	B
Illuminant	Multicolor LEDs, max. 9 W max 234 lm, life span: 30000 h
Remote control	RF
Battery (SLA)	12V, 7Ah, operating time 15 h
Charger	100-240 VAC, 50/60 Hz, Vout: 5V, 1 A
Protection Class	III (Product), II (Charger)
IP 20	for indoor use

Modèle	LOUNGE M 45: 27-03-45 / LOUNGE M 55: 27-03-55 LOUNGE M 75: 27-03-75 / LOUNGE M 105: 27-03-105
Matériaux/	ABS, PMMA brillant, blanc, translucide ré- Couleur sistant aux rayons UV; Aluminium brossé
Dimensions	Ø env. 60, H 45/55/75/105 cm
Poids	env. 24 Kg
Classe énergétique	B
Ampoule	LED multicoloreurs, max 9 W max 234 lm, Durée de vie: 30000h
Commande	Radio contrôle
Batterie (SLA)	12V, 7Ah, operating time 15 h
Chargeur	100-240 VAC, 50/60 Hz, Vout: 5V, 1 A
Catégorie	III; II (Chargeur) utilisation intérieur IP 20

NEW

Inklusiv: 5 mm Glasplatte
Including: 5 mm glass top
Inclus: 5 mm tablette en verre



LOUNGE M 45/55/75/105 OUTDOOR



LOUNGE M 45/55/75/105 OUTDOOR LED



LOUNGE M 45/55/75/105 LED ACCU OUTDOOR



DE	Modell LOUNGE M 45: 27-07-45 / LOUNGE M 55: 27-07-55 LOUNGE M 75: 27-07-75 / LOUNGE M 105: 27-07-105
Material/ Farbe	ABS, PMMA glänzend, weiß transluzent, UV-beständig; Aluminium gebürstet
Maße	Ø ca. 60, H 45/55/75/105 cm
EE-Klasse	A++ - E
Gewicht	ca. 15,9/16,1/16,5/20,8 kg
Leuchtmittel	1x max. 28 W E27
Verkabelung	ca. 4,4/4,3/4,1/3,8 m, schwarz
Spannung	230 V-, 50 Hz
Schutzklasse	II
IP 44	für Aussenbereich geeignet

Modell LOUNGE M 45: 27-05-45 / LOUNGE M 55: 27-05-55 LOUNGE M 75: 27-05-75 / LOUNGE M 105: 27-05-105	
Material/ Farbe	ABS, PMMA glänzend, weiß transluzent, UV-beständig; Aluminium gebürstet
Maße	Ø ca. 60, H 45/55/75/105 cm
Gewicht	ca. 15,1/15,3/15,7/20 kg
EE-Klasse	A++ - E
Leuchtmittel	Multicolor LED Leuchtmittel E27 max. 9 W mit Fernbedienung EEK: A, max. 850 lm Lebensdauer: 50.000 Std.
Fernbedienung	Funk
Verkabelung	ca. 4,4/4,3/4,1/3,8 m, schwarz
Schutzklasse	230 V-, 50Hz
Spannung	II
IP 44	für Aussenbereich geeignet

Modell LOUNGE M 45: 27-03-45 / LOUNGE M 55: 27-03-55 LOUNGE M 75: 27-03-75 / LOUNGE M 105: 27-03-105	
Material/ Farbe	ABS, PMMA glänzend, weiß transluzent, UV-beständig; Aluminium gebürstet
Maße	Ø ca. 60, H 45/55/75/105 cm
Gewicht	ca. 15,1/15,3/15,7/20 kg
EE-Klasse	B
Leuchtmittel	Multicolor LEDs, max. 4 W, max 136 lm, Lebensdauer: 30000 Std.
Fernbedienung	IR
Akku (Li-Ion)	3.7V / 2 x 2200 mAh Betriebsdauer 10 h
Ladegerät	100-240VAC, 50/60Hz, Vout 7.5V/0,6A
Schutzklasse	III (Produkt), II (Ladegerät)
IP 44	Für Außenbereich geeignet

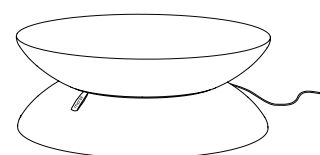

LOUNGE INDOOR



Modell	04-05-01
Material	ABS, PMMA glänzend beschichtet, UV-beständig
Farbe	weiß, transluzent
Maße	Ø ca. 84 cm, H 34 cm
Gewicht	ca. 7 kg
EE-Klasse	A++ - E
Leuchtmittel	1x max. 60 W E27
Verkabelung	ca. 3 m mit Fußschalter, klar
Spannung	220-240 V-, 50 Hz
Schutzklasse	II
IP 20	für Innenbereich geeignet



LOUNGE INDOOR LED



Modell	04-05-01-LED
Material	ABS, PMMA glänzend beschichtet, UV-beständig
Farbe	weiß, transluzent
Maße	Ø ca. 84 cm, H 34 cm
Gewicht	ca. 7 kg
EE-Klasse	A++ - E
Leuchtmittel	Multicolor LED Leuchtmittel E27 max. 9 W mit Fernbedienung EEK: A, max. 850 lm Lebensdauer: 50.000 Std.
Fernbedienung	Funk
Verkabelung	ca. 3 m mit Fußschalter, klar
Spannung	230 V-, 50Hz
Schutzklasse	II
IP 20	für Innenbereich geeignet

EN	Model LOUNGE M 45: 27-07-45 / LOUNGE M 55: 27-07-55 LOUNGE M 75: 27-07-75 / LOUNGE M 105: 27-07-105
Material/ Colour	ABS, PMMA glossy, white translucent UV resistant; aluminium brushed
Dimensions	Ø approx. 60, H 45/55/75/105 cm
EE-Class	A++ - E
Weight	approx. 15,9/16,1/16,5/20,8 kg
Illuminant	1x max. 28 W E27
Cable	approx. 4,4/4,3/4,1/3,8 m, black
Voltage	230 V-, 50 Hz
Protection Class	II
IP 44	for outdoor use

Model LOUNGE M 45: 27-05-45 / LOUNGE M 55: 27-05-55 LOUNGE M 75: 27-05-75 / LOUNGE M 105: 27-05-105	
Material/ Colour	ABS, PMMA glossy, white translucent UV resistant; aluminium brushed
Dimensions	Ø approx. 60, H 45/55/75/105 cm
Weight	approx. 15,1/15,3/15,7/20 kg
EE-Class	A++ - E
Illuminant	LED multicolor light bulb E27, max. 9 W with remote control EEC: A, max. 850 lm Life span: 50.000 h
Remote Control	RF
Cable	approx. 4,4/4,3/4,1/3,8 m, black
Voltage	230 V-, 50Hz
Protection Class	II
IP 44	for outdoor use

Model LOUNGE M 45: 27-03-45 / LOUNGE M 55: 27-03-55 LOUNGE M 75: 27-03-75 / LOUNGE M 105: 27-03-105	
Material/ Colour	ABS, PMMA glossy, white translucent UV resistant; aluminium brushed
Dimensions	Ø approx. 60, H 45/55/75/105 cm
Weight	approx. 15,1/15,3/15,7/20 kg
EE-Class	B
Illuminant	Multicolor LEDs, max. 4 W, max 136 lm, life span: 30.000 h
Remote control	IR
Battery (Li-Ion)	3.7V / 2 x 2200 mAh operating time 10 h
Charger	100-240VAC, 50/60Hz, Vout 7.5V/0,6A
Protection Class	III (Product), II (Charger)
IP 44	for outdoor use

Model	04-05-01
Material	ABS, PMMA coated, gloss finish, UV resistant
Colour	white, translucent
Dimensions	Ø approx. 84 cm, H 34 cm
Weight	approx. 7 kg
EE-Class	A++ - E
Illuminant	1x max. 60 W E 27
Cable	approx. 3 m cable, clear
Voltage	220-240V-, 50Hz
Protection Class	II
IP 20	for indoor use

Model	04-05-01-LED
Material	ABS, PMMA coated, gloss finish, UV resistant
Colour	white, translucent
Dimensions	Ø approx. 84 cm, H 34 cm
Weight	approx. 7 kg
EE-Class	A++ - E
Illuminant	LED multicolor light bulb E27, max. 9 W with remote control EEC: A, max. 850 lm Life span: 50.000 h
Remote Control	RF
Cable	approx. 3 m cable, clear
Voltage	230 V-, 50Hz
Protection Class	II
IP 20	for indoor use

FR	Modèle LOUNGE M 45: 27-07-45 / LOUNGE M 55: 27-07-55 LOUNGE M 75: 27-07-75 / LOUNGE M 105: 27-07-105
Matériau/ Couleur	ABS, PMMA brillant, blanc, translucide ré- sistant aux rayons UV; Aluminium brossé
Dimensions	Ø env. 60, H 45/55/75/105 cm
Poids	env. 15,9/16,1/16,5/20,8 kg
Classe énergétique	A++ - E
Ampoule	1x max. 28 W E27
Câblage	env. 4,4/4,3/4,1/3,8 m, noir
Tension	230 V-, 50 Hz
Catégorie	II
IP 44	pour utilisation extérieure

Modèle LOUNGE M 45: 27-05-45 / LOUNGE M 55: 27-05-55 LOUNGE M 75: 27-05-75 / LOUNGE M 105: 27-05-105	
Matériau/ Couleur	ABS, PMMA brillant, blanc, translucide ré- sistant aux rayons UV; Aluminium brossé
Dimensions	Ø env. 60, H 45/55/75/105 cm
Poids	env. 15,1/15,3/15,7/20 kg
Classe énergétique	A++ - E
Ampoule LED multicolore	LED multicolours E27/ max. 9 W avec télé- commande/ CÉ: A, max. 850 lm/ Durée de vie: 50.000h
Télécommande	Radio contrôle
Câblage	env. 4,4/4,3/4,1/3,8 m, noir
Tension	230 V-, 50Hz
Catégorie	II
IP 44	pour utilisation extérieure

Modèle LOUNGE M 45: 27-03-45 / LOUNGE M 55: 27-03-55 LOUNGE M 75: 27-03-75 / LOUNGE M 105: 27-03-105	
Matériau/ Couleur	ABS, PMMA brillant, blanc, translucide ré- sistant aux rayons UV; Aluminium brossé
Dimensions	Ø env. 60, H 45/55/75/105 cm
Poids	env. 15,1/15,3/15,7/20 kg
Classe énergétique	B
Ampoule	LED multicolours, max 4 W max 136 lm, Durée de vie: 30000h
Commande	IR
Batterie (Li-Ion)	3.7V/2x2200mAh, autonomie: 10h
Chargeur	100-240VAC, 50/60Hz, Vout 7.5V/0,6A
Catégorie	III (Produit), II (Chargeur)
IP 44	pour utilisation extérieure

Modèle	04-05-01
Matériaux	ABS, PMMA, brillant, résistant aux rayons UV
Couleur	blanc, translucide
Dimensions	Ø env. 84 cm, H 34 cm
Poids	env. 7 kg
Classe énergétique	A++ - E
Ampoule	1 x max. 60 W E27
Câblage	env. 3 m, transparent
Tension	220-240 V-, 50 Hz
Catégorie	II
IP 20	pour utilisation intérieur

Modèle	04-05-01-LED
Matériaux	ABS, PMMA, brillant, résistant aux rayons UV
Couleur	blanc, translucide
Dimensions	Ø env. 84 cm, H 34 cm
Poids	env. 7 kg
Classe énergétique	A++ - E
Ampoule	Ampoule LED multicolours E27 max. 9 W avec télécommande CÉ: A, max. 850 lm Durée de vie: 50.000h
Télécommande	Radio contrôle
Câblage	env. 3 m, transparent
Tension	230 V-, 50Hz
Catégorie	II
IP 20	pour utilisation intérieur



LOUNGE LED PRO ACCU



Modell	04-06-01
Material	ABS, PMMA glänzend beschichtet, UV-beständig
Farbe	weiß, transluzent
Maße	Ø ca. 84 cm, H 34 cm
Gewicht	ca. 14 kg
EE-Klasse	B
Leuchtmittel	Multicolor LEDs, max. 13 W, max 234 lm, Lebensdauer: 35000 Std.
Fernbedienung	Funk
Akku (SLA)	12 V, 18 Ah, Betriebsdauer 25 h
Ladegerät	110-240 V~, 50-60 Hz Vout 12 V, 3 A
Schutzklasse	III (Produkt), II (Ladegerät)
IP 20	für Innenbereich geeignet

Model	04-06-01
Material	ABS, PMMA coated, gloss finish, UV resistant
Colour	white, translucent
Dimensions	Ø approx. 84 cm, H 34 cm
Weight	approx. 14 kg
EE-Class	B
Illuminant	Multicolor LEDs, max. 13 W max 234 lm, life span: 35000 h
Remote control	RF
Battery (SLA)	12V, 18Ah, operating time 25 h
Charger	110-240 V~, 50-60 Hz Vout 12 V, 3 A
Protection Class	III (Product), II (Charger)
IP 20	for indoor use

Modèle	04-06-01
Matériaux	ABS, PMMA, brillant, résistant aux rayons UV
Couleur	blanc, translucide
Dimensions	Ø env. 84 cm, H 34 cm
Poids	env. 14 kg
Classe énergétique	B
Ampoule	LED multicolore, max 13 W max 234 lm, Durée de vie: 35000h
Commande	Radio contrôle
Batterie (SLA)	12 V, 18Ah, autonomie 25 h
Chargeur	110-240V~, 50-60Hz Vout 12V, 3A
Catégorie	III (Produit), II (Chargeur)
IP 20	approprié pour utilisation intérieur

Inklusiv: 5 mm Glasplatte
Including: 5 mm glass top
Inclus: 5 mm tablette en verre



LOUNGE OUTDOOR LED



Modell	04-03-01-LED
Material	ABS, PMMA glänzend beschichtet, UV-beständig
Farbe	weiß, transluzent
Maße	Ø ca. 84 cm, H 34 cm
Gewicht	ca. 8 kg
EE-Klasse	A++ - E
Leuchtmittel	Multicolor LED Leuchtmittel E27 max. 9 W mit Fernbedienung EEK: A, max. 850 lm Lebensdauer: 50.000 Std.
Fernbedienung	Funk
Verkabelung	ca. 5 m Kabel, schwarz
Schutzklasse	230 V~, 50Hz
Spannung	II
IP 44	für Aussenbereich geeignet

Model	04-03-01-LED
Material	ABS, PMMA coated, gloss finish, UV resistant
Colour	white, translucent
Dimensions	Ø approx. 84 cm, H 34 cm
Weight	approx. 8 kg
EE-Class	A++ - E
Illuminant	LED multicolor light bulb E27, max. 9 W with remote control EEC: A, max. 850 lm Life span: 50.000 h
Remote Control	RF
Cable	approx. 5 m cable, black
Voltage	230 V~, 50Hz
Protection Class	II
IP 44	for outdoor use

Modèle	04-03-01-LED
Matériaux	ABS, PMMA, brillant, résistant aux rayons UV
Couleur	blanc, translucide
Dimensions	Ø env. 84 cm, H 34 cm
Poids	env. 8 kg
Classe énergétique	A++ - E
Ampoule	Ampoule LED multicolore E27 max 9 W avec télécommande CE: A, max. 850 lm Durée de vie: 50.000 h
Télécommande	Radio contrôle
Câblage	env. 5 m, noir
Tension	230 V~, 50Hz
Catégorie	II
IP 44	pour utilisation extérieure



Inklusiv: 4 mm Glasplatte
Including: 4 mm glass top
Inclus: 4 mm tablette en verre



LOUNGE MINI LED



Modell	04-02-01
Material	ABS, PMMA glänzend beschichtet, UV-beständig
Farbe	weiß, transluzent
Maße	Ø ca. 39 cm, H 33 cm
Gewicht	ca. 2 kg
EE-Klasse	A++ - E
Leuchtmittel	1x max. 25 W E27
Verkabelung	ca. 3 m mit Fußschalter, klar
Spannung	230 V~, 50 Hz
Schutzklasse	II
IP 20	für Innenbereich geeignet

Model	04-02-01
Material	ABS, PMMA coated, gloss finish, UV resistant
Colour	white, translucent
Dimensions	Ø approx. 39 cm, H 33 cm
Weight	approx. 2 kg
EE-Class	A++ - E
Illuminant	1x max. 25 W E27
Cable	approx. 3 m cable, clear
Voltage	230 V~, 50 Hz
Protection Class	II
IP 20	for indoor use

Modèle	04-02-01
Matériaux	ABS, PMMA, brillant, résistant aux rayons UV
Couleur	blanc, translucide
Dimensions	Ø env. 39 cm, H 33 cm
Poids	env. 2 kg
Classe énergétique	A++ - E
Ampoule	1 x max. 25 W E27
Câblage	env. 3 m, transparent
Tension	230 V~, 50 Hz
Catégorie	II
IP 20	pour utilisation intérieur

Modell	04-02-01-LED
Material	ABS, PMMA glänzend beschichtet, UV-beständig
Farbe	weiß, transluzent
Maße	Ø ca. 39 cm, H 33 cm
Gewicht	ca. 2 kg
EE-Klasse	A++ - E
Leuchtmittel	Multicolor LED Leuchtmittel E27 max. 9 W mit Fernbedienung EEK: A, max. 850 lm Lebensdauer: 50.000 Std.
Fernbedienung	Funk
Verkabelung	ca. 3 m mit Fußschalter, klar
Spannung	230 V~, 50 Hz
Schutzklasse	II
IP 20	für Innenbereich geeignet

Model	04-02-01-LED
Material	ABS, PMMA coated, gloss finish, UV resistant
Colour	white, translucent
Dimensions	Ø approx. 39 cm, H 33 cm
Weight	approx. 2 kg
EE-Class	A++ - E
Illuminant	LED multicolor light bulb E27, max. 9 W with remote control EEC: A, max. 850 lm Life span: 50.000 h
Remote Control	RF
Cable	approx. 3 m cable, clear
Voltage	230 V~, 50 Hz
Protection Class	II
IP 20	for indoor use

Modèle	04-02-01-LED
Matériaux	ABS, PMMA, brillant, résistant aux rayons UV
Couleur	blanc, translucide
Dimensions	Ø env. 39 cm, H 33 cm
Poids	env. 2 kg
Classe énergétique	A++ - E
Ampoule	Ampoule LED multicolore E27 max 9 W avec télécommande CE: A, max. 850 lm Durée de vie: 50.000 h
Télécommande	Radio contrôle
Câblage	env. 3 m, transparent
Tension	230 V~, 50 Hz
Catégorie	II
IP 20	pour utilisation intérieur

NEW



Inklusiv: 4 mm Glasplatte
Including: 4 mm glass top
Inclus: 4 mm tablette en verre

LOUNGE MINI CABLE ORGANIZER



DE	Modell	04-02-05
	Material	ABS, PMMA glänzend beschichtet, UV-beständig
	Farbe	weiß, transluzent
	Maße	Ø ca. 39 cm, H 33 cm
	Gewicht	ca. 2 kg
	IP 20	für Innenbereich geeignet

EN	Model	04-02-05
	Material	ABS, PMMA coated, gloss finish, UV resistant
	Colour	white, translucent
	Dimensions	Ø approx. 39 cm, H 33 cm
	Weight	approx. 2 kg
	IP 20	for indoor use

FR	Modèle	04-02-05
	Matériaux	ABS, PMMA, brillant, résistant aux rayons UV
	Couleur	blanc, translucide
	Dimensions	Ø env. 39 cm, H 33 cm
	Poids	env. 2 kg
	IP 20	pour utilisation intérieur

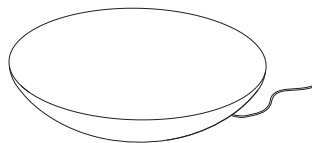

LOUNGE VARIATION INDOOR



Modell	07-01-01
Material	ABS, PMMA glänzend beschichtet, UV-beständig
Farbe	weiß, transluzent
Maße	Ø ca. 84 cm, H 18 cm
Gewicht	ca. 8 kg
EE-Klasse	A++ - E
Leuchtmittel	1x max. 42 W E27
Verkabelung	ca. 3,5 m, klar
Spannung	230 V~, 50 Hz
Schutzklasse	II
IP 20	für Innenbereich geeignet

Model	07-01-01
Material	ABS, PMMA coated, gloss finish, UV resistant
Colour	white, translucent
Dimensions	Ø approx. 84 cm, H 18 cm
Weight	approx. 8 kg
EE-Class	A++ - E
Illuminant	1x max. 42 W E27
Cable	approx. 3.5 m cable, clear
Voltage	230 V~, 50 Hz
Protection Class	II
IP 20	for indoor use

Modèle	07-01-01
Matériaux	ABS, PMMA, brillant, résistant aux rayons UV
Couleur	blanc, translucide
Dimensions	Ø env. 84 cm, H 18 cm
Poids	env. 8 kg
Classe énergétique	A++ - E
Ampoule	1x max. 42 W E27
Câblage	env. 3,5 m, transparent
Tension	230 V~, 50 Hz
Catégorie	II
IP 20	pour utilisation intérieur



LOUNGE VARIATION LED PRO



Modell	07-03-01
Material	ABS, PMMA glänzend beschichtet, UV-beständig
Farbe	weiß, transluzent
Maße	Ø ca. 84 cm, H 18 cm
Gewicht	ca. 9 kg
EE-Klasse	A++ - E
Leuchtmittel	Multicolor LED Leuchtmittel E27 max. 9 W mit Fernbedienung EEK: A, max. 850 lm Lebensdauer: 50.000 Std.
Fernbedienung	Funk
Verkabelung	ca. 3,5 m Kabel, klar
Spannung	230 V~, 50 Hz
Schutzklasse	II
IP 20	für Innenbereich geeignet

Model	07-03-01
Material	ABS, PMMA coated, gloss finish, UV resistant
Colour	white, translucent
Dimensions	Ø approx. 84 cm, H 18 cm
Weight	approx. 9 kg
EE-Class	A++ - E
Illuminant	LED multicolor light bulb E27, max. 9 W with remote control EEC: A, max. 850 lm Life span: 50.000 h
Remote Control	RF
Cable	approx. 3.5 m cable, clear
Voltage	230 V~, 50 Hz
Protection Class	II
IP 20	for indoor use

Modèle	07-03-01
Matériaux	ABS, PMMA, brillant, résistant aux rayons UV
Couleur	blanc, translucide
Dimensions	Ø env. 84 cm, H 18 cm
Poids	env. 9 kg
Classe énergétique	A++ - E
Ampoule	Ampoule LED multicolours E27 max. 9 W avec télécommande CE: A, max. 850 lm Durée de vie: 50.000 h
Télécommande	Radio contrôle
Câblage	env. 3,5 m, transparent
Tension	230 V~, 50 Hz
Catégorie	II
IP 20	pour utilisation intérieur

LOUNGE VARIATION OUTDOOR



Modell	07-02-01
Material	ABS, PMMA glänzend beschichtet, UV-beständig
Farbe	weiß, transluzent
Maße	Ø ca. 84 cm, H 18 cm
Gewicht	ca. 9 kg
EE-Klasse	A++ - E
Leuchtmittel	1x max. 42 W E27
Verkabelung	ca. 4,5 m Kabel, schwarz
Spannung	230 V~, 50 Hz
Schutzklasse	II
IP 44	für Aussenbereich geeignet

Model	07-02-01
Material	ABS, PMMA coated, gloss finish, UV resistant
Colour	white, translucent
Dimensions	Ø approx. 84 cm, H 18 cm
Weight	approx. 9 kg
EE-Class	A++ - E
Illuminant	1x max. 42 W E27
Cable	approx. 4.5 m cable, black
Voltage	230 V~, 50 Hz
Protection Class	II
IP 44	for outdoor use

Modèle	07-02-01
Matériaux	ABS, PMMA, brillant, résistant aux rayons UV
Couleur	blanc, translucide
Dimensions	Ø env. 84 cm, H 18 cm
Poids	env. 9 kg
Classe énergétique	A++ - E
Ampoule	1x max. 42 W E27
Câblage	env. 4,5 m, noir
Tension	230 V~, 50 Hz
Catégorie	II
IP 44	pour utilisation extérieure

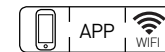

LOUNGE VARIATION LED PRO OUTDOOR



Modell	07-03-02
Material	ABS, PMMA glänzend beschichtet, UV-beständig
Farbe	weiß, transluzent
Maße	Ø ca. 84 cm, H 18 cm
Gewicht	ca. 9 kg
EE-Klasse	A++ - E
Leuchtmittel	Multicolor LED Leuchtmittel E27 max. 9 W mit Fernbedienung EEK: A, max. 850 lm Lebensdauer: 50.000 Std.
Fernbedienung	Funk
Verkabelung	ca. 4,5 m Kabel, schwarz
Spannung	230 V~, 50 Hz
Schutzklasse	II
IP 44	für Aussenbereich geeignet

Model	07-03-02
Material	ABS, PMMA coated, gloss finish, UV resistant
Colour	white, translucent
Dimensions	Ø approx. 84 cm, H 18 cm
Weight	approx. 9 kg
EE-Class	A++ - E
Illuminant	LED multicolor light bulb E27, max. 9 W with remote control EEC: A, max. 850 lm Life span: 50.000 h
Remote Control	RF
Cable	approx. 4.5 m cable, black
Voltage	230 V~, 50 Hz
Protection Class	II
IP 44	for outdoor use

Modèle	07-03-02
Matériaux	ABS, PMMA, brillant, résistant aux rayons UV
Couleur	blanc, translucide
Dimensions	Ø env. 84 cm, H 18 cm
Poids	env. 9 kg
Classe énergétique	A++ - E
Ampoule	Ampoule LED multicolours E27 max. 9 W avec télécommande CE: A, max. 850 lm Durée de vie: 50.000 h
Télécommande	Radio contrôle
Câblage	env. 4,5 m, noir
Tension	230 V~, 50 Hz
Catégorie	II
IP 44	pour utilisation extérieure

Inklusiv: 5 mm Glasplatte
Including: 5 mm glass top
Inclus: 5 mm tablette en verre

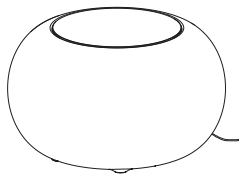

BUBBLE X



Modell	15-07-01 (weiß) 15-07-02 (Granitoptik) NEW
Material	PE seidenmatt, UV-beständig
Farbe	weiß, transluzent Grau, Granitoptik
Maße	ca. Ø 68 x H 41 cm
Gewicht	ca. 7 kg
Leuchtmittel	Produkt ist nicht leuchtend
IP 20	für Innenbereich geeignet

Model	15-01-01 (White) 15-07-02 (Granite) NEW
Material	PE semi gloss, UV resistant
Colour	white, translucent Grey Granite
Dimensions	approx. Ø 68 x H 41 cm
Weight	approx. 7 kg
Illuminant	Product can not be illuminated
IP 20	for indoor use

Modèle	15-01-01 (Blanc) 15-07-02 (Granite) NEW
Matériaux	PE satiné, résistant aux rayons UV
Couleur	blanc, translucide Gris, la finition du granite
Dimensions	env. Ø 68 x H 41 cm
Poids	env. 7 kg
Ampoule	Le produit n'a pas de lumière
IP 20	pour utilisation intérieur

BUBBLE INDOOR



Modell	15-01-01 (weiß) 15-01-02 (Granitoptik) NEW
Material	PE seidenmatt, UV-beständig
Farbe	weiß, transluzent Grau, Granitoptik
Maße	ca. Ø 68 x H 41 cm
Gewicht	ca. 7 kg
EE-Klasse	A++ - E
Leuchtmittel	1x max. 40 W E27
Verkabelung	ca. 3 m mit Fußschalter, klar
Spannung	230 V-, 50Hz
Schutzklasse	II
IP 20	für Innenbereich geeignet

Model	15-01-01 (White) 15-01-02 (Granite) NEW
Material	PE semi gloss, UV resistant
Colour	white, translucent Grey Granite
Dimensions	approx. Ø 68 x H 41 cm
Weight	approx. 7 kg
EE-Class	A++ - E
Illuminant	1x max. 40 W E27
Cable	approx. 3 m cable, clear
Voltage	230 V-, 50Hz
Protection Class	II
IP 20	for indoor use

Modèle	15-01-01 (Blanc) 15-01-02 (Granite) NEW
Matériaux	PE satiné, résistant aux rayons UV
Couleur	blanc, translucide Gris, la finition du granite
Dimensions	env. Ø 68 x H 41 cm
Poids	env. 7 kg
Classe énergétique	A++ - E
Ampoule	1 x max. 40 W E27
Câblage	env. 3 m, transparent
Tension	230 V-, 50Hz
Catégorie	II
IP 20	pour utilisation intérieur



BUBBLE INDOOR LED



Modell	15-01-01-LED (weiß) 15-01-02-LED (Granitoptik) NEW
Material	PE seidenmatt, UV-beständig
Farbe	weiß, transluzent/ Grau, Granitoptik
Maße	ca. Ø 68 x H 41 cm
Gewicht	ca. 7 kg
EE-Klasse	A++ - E
Leuchtmittel	Multicolor LED Leuchtmittel E27 max. 9W mit Fernbedienung EEK: A, max. 850 lm Lebensdauer: 50.000 Std.
Fernbedienung	Funk
Verkabelung	ca. 3 m mit Fußschalter, klar
Spannung	230 V-, 50Hz
Schutzklasse	II
IP 20	für Innenbereich geeignet

Model	15-01-01-LED (White) 15-01-02-LED (Granite) NEW
Material	PE semi gloss, UV resistant
Colour	white, translucent/ Grey Granite
Dimensions	approx. Ø 68 x H 41 cm
Weight	approx. 7 kg
EE-Class	A++ - E
Illuminant	LED multicolor light bulb E27, max. 9W with remote control EEC: A, max. 850 lm Life span: 50.000 h
Remote Control	RF
Cable	approx. 3 m cable, clear
Voltage	230 V-, 50Hz
Protection Class	II
IP 20	for indoor use

Modèle	15-01-01-LED (Blanc) 15-01-02-LED (Granite) NEW
Matériaux	PE satiné, résistant aux rayons UV
Couleur	blanc, translucide/ gris, granite
Dimensions	env. Ø 68 x H 41 cm
Poids	env. 7 kg
Classe énergétique	A++ - E
Ampoule LED multicolours E27 max. 9W avec télécommande/ CÉ: A, max. 850 lm/ Durée de vie: 50.000 h	
Télécommande	Radio contrôle
Câblage	env. 3 m, transparent
Tension	230 V-, 50Hz
Catégorie	II
IP 20	pour utilisation intérieur



BUBBLE LED PRO ACCU



Modell	15-03-01
Material	PE seidenmatt, UV-beständig
Farbe	weiß, transluzent
Maße	ca. Ø 68 x H 41 cm
Gewicht	ca. 14 kg
EE-Klasse	B
Leuchtmittel	Multicolor LEDs, max. 13 W, max 234 lm, Lebensdauer: 35000 Std.
Fernbedienung	Funk
Akku (SLA)	12V, 18 Ah, Betriebsdauer: 25 h
Ladegerät	110-240 V-, 50-60 Hz Vout 12V, 3 A
Schutzklasse	III (Produkt), II (Ladegerät)
IP 20	für Innenbereich geeignet

Model	15-03-01
Material	PE semi gloss, UV resistant
Colour	white, translucent
Dimensions	approx. Ø 68 x H 41 cm
Weight	approx. 14 kg
EE-Class	B
Illuminant	Multicolor LEDs, max. 13 W max 234 lm, life span: 35000 h
Remote control	RF
Battery (SLA)	12V, 18 Ah, operating time 25 h
Charger	110-240 V-, 50-60 Hz Vout 12V, 3 A
Protection Class	III (Product), II (Charger)
IP 20	for indoor use

Modèle	15-03-01
Matériaux	PE satiné, résistant aux rayons UV
Couleur	blanc, translucide
Dimensions	env. Ø 68 x H 41 cm
Poids	env. 14 kg
Catégorie énergétique	B
Ampoule	LED multicolours, max 13 W max 234 lm, Durée de vie: 35000h
Commande	Radio contrôle
Batterie (SLA)	12V, 18 Ah, autonomie 25 h
Chargeur	110-240 V-, 50-60 Hz Vout 12V, 3 A
Catégorie	III (Produit), II (Chargeur)
IP 20	pour utilisation intérieur

BUBBLE OUTDOOR

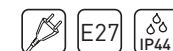

Modell	15-02-01 (weiß) 15-02-02 (Granitoptik) NEW
Material	PE seidenmatt, UV-beständig
Farbe	weiß, transluzent Grau, Granitoptik
Maße	ca. Ø 68 x H 41 cm
Gewicht	ca. 8 kg
EE-Klasse	A++ - E
Leuchtmittel	1x max. 40 W
Verkabelung	ca. 5 m Kabel, schwarz
Spannung	230 V-, 50Hz
Schutzklasse	II
IP 44	für Aussenbereich geeignet

Model	15-02-01 (White) 15-02-02 (Granite) NEW
Material	PE semi gloss, UV resistant
Colour	white, translucent Grey Granite
Dimensions	approx. Ø 68 x H 41 cm
Weight	approx. 8 kg
EE-Class	A++ - E
Illuminant	1x max. 40 W E27
Cable	approx. 5 m cable, black
Voltage	230 V-, 50Hz
Protection Class	II
IP 44	for outdoor use

Modèle	15-02-01 (Blanc) 15-02-02 (Granite) NEW
Matériaux	PE satiné, résistant aux rayons UV
Couleur	blanc, translucide Gris, la finition du granite
Dimensions	env. Ø 68 x H 41 cm
Poids	env. 8 kg
Classe énergétique	A++ - E
Ampoule	1x max. 40 W E27
Câblage	env. 5 m, noir
Tension	230 V-, 50Hz
Catégorie	II
IP 44	pour utilisation extérieure

Inklusiv: Glasplatte oder Sitzkissen
Including: Glass top or cushion
Inclus: Panneau de verre ou coussin



BUBBLE OUTDOOR LED



DE	Modell	15-02-01 -LED (weiß) 15-02-02-LED (Granitoptik) NEW
	Material	PE seidenmatt, UV-beständig
	Farbe	weiß, transluzent/ Grau, Granitoptik
	Maße	ca. Ø 68 x H 41 cm
	Gewicht	ca. 8 kg
	EE-Klasse	A++ - E
	Leuchtmittel	Multicolor LED Leuchtmittel E27 max. 9 W mit Fernbedienung EEK: A, max. 850 lm Lebensdauer: 50.000 Std.
	Fernbedienung	Funk
	Verkabelung	ca. 5 m Kabel, schwarz
	Spannung	230 V~, 50Hz
	Schutzklasse	II
	IP 44	für Außenbereich geeignet

EN	Model	15-02-01-LED (White) 15-02-02-LED (Granite) NEW
	Material	PE semi gloss, UV resistant
	Colour	white, translucent/ Grey Granite
	Dimensions	approx. Ø 68 x H 41 cm
	Weight	approx. 8 kg
	EE-Class	A++ - E
	Illuminant	LED multicolor light bulb E27, max. 9 W with remote control EEC: A, max. 850 lm Life span: 50.000 h
	Remote Control	RF
	Cable	approx. 5 m cable, black
	Voltage	230 V~, 50Hz
	Protection Class	II
	IP 44	for outdoor use

FR	Modèle	15-02-01-LED (Blanc) 15-02-02-LED (Granite) NEW
	Matériaux	PE satiné, résistant aux rayons UV
	Couleur	blanc, translucide/ gris, granite
	Dimensions	env. Ø 68 x H 41 cm
	Poids	env. 8 kg
	Classe énergétique	A++ - E
	Ampoule	LED multicolours E27 max 9 W avec télé- commande/ CÉ: A, max. 850 lm/ Durée de vie: 50.000 h
	Télécommande	Radio contrôle
	Câblage	env. 5 m, noir
	Tension	230 V~, 50Hz
	Catégorie	II
	IP 44	pour utilisation extérieure

BUBBLE LED ACCU OUTDOOR



Modell	15-04-02
Material	PE seidenmatt, UV-beständig
Farbe	weiß, transluzent
Maße	ca. Ø 68 x H 41 cm
Gewicht	ca. 6 kg
EE-Klasse	B
Leuchtmittel	Multicolor LEDs, max. 4 W, max 136 lm, Lebensdauer: 30000 Std.
Fernbedienung	IR
Akku (Li-Ion)	3.7 V / 2 x 2200 mAh Betriebsdauer 10 h
Ladegerät	100-240 VAC, 50/60 Hz, Vout 7.5V/0,6 A
Schutzklasse	III (Produkt), II (Ladegerät)
IP 54	Für Außenbereich geeignet

Model	15-04-02
Material	PE semi gloss, UV resistant
Colour	white, translucent
Dimensions	approx. Ø 68 x H 41 cm
Weight	approx. 6 kg
EE-Class	B
Illuminant	Multicolor LEDs, max. 4 W, max 136 lm, life span: 30.000 h
Remote control	IR
Battery (Li-Ion)	3.7 V / 2 x 2200 mAh operating time 10 h
Charger	100-240 VAC, 50/60 Hz, Vout 7.5V/0,6 A
Protection Class	III (Product), II (Charger)
IP 54	for outdoor use

Modèle	15-04-02
Matériaux	PE satiné, résistant aux rayons UV
Couleur	blanc, translucide
Dimensions	env. Ø 68 x H 41 cm
Poids	env. 6 kg
Classe énergétique	B
Ampoule	LED multicolours, max 4 W max 136 lm, Durée de vie: 30000h
Commande	IR
Batterie (Li-Ion)	3.7 V / 2 x 2200 mAh autonomie: 10 h
Chargeur	100-240 VAC, 50/60 Hz, Vout 7.5V/0,6 A
Catégorie	III (Produit), II (Chargeur)
IP 54	pour utilisation extérieure

BUBBLE CUSHIONS & GLASSTOP



Modell	15-11-01 Sitzkissen Orange 15-12-01 Sitzkissen Rot 15-13-01 Sitzkissen Violett 15-14-01 Sitzkissen Grün 15-15-01 Sitzkissen Anthrazit
Material	Filz, 100% Wolle
Maße	Ø 40 x H 5 cm
Gewicht	ca. 0.2 kg
Modell	15-10-01 Glastischplatte
Material	Sicherheitsglas, klar
Maße	Ø 40 x H 5 cm
Gewicht	1,5 kg

Model	15-11-01 Orange cushion 15-12-01 Red cushion 15-13-01 Purple cushion 15-14-01 Green cushion 15-15-01 Anthracite cushion
Material	Felt, 100% wool
Dimensions	Ø 40 x H 5 cm
Weight	approx. 0.2 kg
Model	15-10-01 Glasstop
Material	Safety glass, transparent
Dimensions	Ø 40 x H 5 cm
Weight	1,5 kg

Modèle	15-11-01 Orange coussin 15-12-01 Rouge coussin 15-13-01 Pourpre coussin 15-14-01 Vert coussin 15-15-01 Anthracite coussin
Matériaux	Feutre, 100% laine
Dimensions	Ø 40 x H 5 cm
Poids	env. 0.2 kg
Modèle	15-10-01 Panneau de verre
Matériaux	Verre de sécurité, transparent
Dimensions	Ø 40 x H 5 cm
Poids	1,5 kg

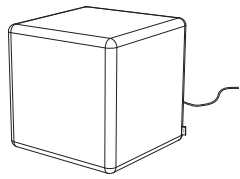

CUBE X/ BOLLARD



Modell	CUBEX 06-07-01 (Weiß) BOLLARD 06-07-02 (Granit) NEW
Material	PE seidenmatt, UV-beständig
Farbe	weiß, transluzent Grau, Granitoptik
Maße	ca. B 44 x L 44 x H 45 cm
Gewicht	ca. 6 kg
Leuchtmittel	Produkt ist nicht leuchtend
IP 20	für Innenbereich geeignet

Model	06-07-01 (White) 06-07-02 (Granite) NEW
Material	PE semi gloss, UV resistant
Colour	white, translucent Grey, Granite finish
Dimensions	approx. W 44 x L 44 x H 45 cm
Weight	approx. 6 kg
Illuminant	Product can not be illuminated
IP 20	for indoor use

Modèle	06-07-01 (Blanc) 06-07-02 (Granite) NEW
Matériaux	PE satiné, résistant aux rayons UV
Couleur	blanc, translucide Gris, la finition du granite
Dimensions	env. La 44 x Lo 44 x H 45 cm
Poids	env. 6 kg
Ampoule	Le produit n'a pas de lumière
IP 20	pour utilisation intérieur

CUBE INDOOR



Modell	06-05-01 (Weiß) 06-05-02 (Granit) NEW
Material	PE seidenmatt, UV-beständig
Farbe	weiß, transluzent/ Grau, Granitoptik
Maße	ca. B 44 x L 44 x H 45 cm
Gewicht	ca. 6 kg
EE-Klasse	A++ - E
Leuchtmittel	1x max. 40 W E27
Verkabelung	ca. 3 m mit Fußschalter, klar
Spannung	230 V~, 50Hz
Schutzklasse	II
IP 20	für Innenbereich geeignet

Model	06-05-01 (White) 06-05-02 (Granite) NEW
Material	PE semi gloss, UV resistant
Colour	white, translucent Grey, Granite finish
Dimensions	approx. W 44 x L 44 x H 45 cm
Weight	approx. 6 kg
EE-Class	A++ - E
Illuminant	1x max. 40 W E27
Cable	approx. 3 m cable, clear
Voltage	230 V~, 50Hz
Protection Class	II
IP 20	for indoor use

Modèle	06-05-01 (Blanc) 06-05-02 (Granite) NEW
Matériaux	PE satiné, résistant aux rayons UV
Couleur	blanc, translucide Gris, la finition du granite
Dimensions	env. La 44 x Lo 44 x H 45 cm
Poids	env. 6 kg
Classe énergétique	A++ - E
Ampoule	1 x max. 40 W E27
Câblage	env. 3 m, transparent
Tension	230 V~, 50Hz
Catégorie	II
IP 20	pour utilisation intérieur



CUBE INDOOR LED



Modell	06-05-01-LED (Weiß) 06-05-02-LED (Granit) NEW
Material	PE seidenmatt, UV-beständig
Farbe	weiß, transluzent/ Grau, Granitoptik
Maße	ca. B 44 x L 44 x H 45 cm
Gewicht	ca. 6 kg
EE-Klasse	A++ - E
Leuchtmittel	Multicolor LED Leuchtmittel E27 max. 9 W mit Fernbedienung EEK: A, max. 850 lm Lebensdauer: 50.000 Std.
Fernbedienung	Funk
Verkabelung	ca. 3 m mit Fußschalter, klar
Spannung	230 V~, 50Hz
Schutzklasse	II
IP 20	für Innenbereich geeignet

Model	06-05-01-LED (White) 06-05-02-LED (Granite) NEW
Material	PE semi gloss, UV resistant
Colour	white, translucent/ Grey, Granite
Dimensions	approx. W 44 x L 44 x H 45 cm
Weight	approx. 6 kg
EE-Class	A++ - E
Illuminant	LED multicolor light bulb E27, max. 9 W with remote control EEC: A, max. 850 lm Life span: 50.000 h
Remote Control	RF
Cable	approx. 3 m cable, clear
Voltage	230 V~, 50Hz
Protection Class	II
IP 20	for indoor use

Modèle	06-05-01-LED (Blanc) 06-05-02-LED (Granite) NEW
Matériaux	PE satiné, résistant aux rayons UV
Couleur	blanc, translucide/ gris, granite
Dimensions	env. La 44 x Lo 44 x H 45 cm
Poids	env. 6 kg
Classe énergétique	A++ - E
Ampoule	LED multicolours E27 max. 9 W avec télé- commande/ CE: A, max. 850 lm/ Durée de vie: 50.000 h
Télécommande	Radio contrôle
Câblage	env. 3 m, avec commutateur au pied, transparent
Tension	230 V~, 50Hz
Catégorie	II
IP 20	pour utilisation intérieur



CUBE LED PRO ACCU



Modell	06-01-01
Material	PE seidenmatt, UV-beständig
Farbe	weiß, transluzent
Maße	ca. B 44 x L 44 x H 45 cm
Gewicht	ca. 13 kg
EE-Klasse	B
Leuchtmittel	Multicolor LEDs, max. 13 W, max 234 lm, Lebensdauer: 35000 Std.
Fernbedienung	Funk
Akku (SLA)	12 V, 18 Ah, Betriebsdauer 25 h
Schutzklasse	III (Produkt), II (Ladegerät)
IP 20	für Innenbereich geeignet

Model	06-01-01
Material	PE semi gloss, UV resistant
Colour	white, translucent
Dimensions	approx. W 44 x L 44 x H 45 cm
Weight	approx. 13 kg
EE-Class	B
Illuminant	Multicolor LEDs, max. 13 W max 234 lm, life span: 35000 h
Remote control	RF
Battery (SLA)	12 V, 18 Ah, operating time 25 h
Charger	110-240 V~, 50-60 Hz Vout 12 V, 3 A
Protection Class	III (Product), II (Charger)
IP 20	for indoor use

Modèle	06-01-01
Matériaux	PE satiné, résistant aux rayons UV
Couleur	blanc, translucide
Dimensions	env. La 44 x Lo 44 x H 45 cm
Poids	env. 13 kg
Classe énergétique	B
Ampoule	LED multicolours, max 13 W max 234 lm, Durée de vie: 35000h
Commande	Radio contrôle
Batterie (SLA)	12 V, 18 Ah, autonomie 25 h
Catégorie	III (Produit), II (Chargeur)
IP 20	pour utilisation intérieur

CUBE OUTDOOR



Modell	06-06-01 (Weiß) 06-06-02 (Granit) NEW
Material	PE seidenmatt, UV-beständig
Farbe	weiß, transluzent Grau, Granitoptik
Maße	ca. B 44 x L 44 x H 45 cm
Gewicht	ca. 6,5 kg
EE-Klasse	A++ - E
Leuchtmittel	1x max. 40 W E27
Verkabelung	ca. 5 m Kabel, schwarz
Spannung	230 V~, 50Hz
Schutzklasse	II
IP 44	für Aussenbereich geeignet

Model	06-06-01 (White) 06-06-02 (Granite) NEW
Material	PE semi gloss, UV resistant
Colour	white, translucent Grey, Granite finish
Dimensions	approx. W 44 x L 44 x H 45 cm
Weight	approx. 6.5 kg
EE-Class	A++ - E
Illuminant	1x max. 40 W E27
Cable	approx. 5 m cable, black
Protection Class	230 V~, 50Hz
IP 44	for outdoor use

Modèle	06-06-01 (Blanc) 06-06-02 (Granite) NEW
Matériaux	PE satiné, résistant aux rayons UV
Couleur	blanc, translucide Gris, la finition du granite
Dimensions	env. La 44 x Lo 44 x H 45 cm
Poids	env. 6,5 kg
Classe énergétique	A++ - E
Ampoule	1 x max. 40 W E27
Câblage	env. 5 m, noir
Tension	230 V~, 50Hz
Catégorie	II
IP 44	pour utilisation extérieure



CUBE OUTDOOR LED



DE	Modell	06-06-01-LED (Weiß) 06-06-02-LED (Granit) NEW
	Material	PE seidenmatt, UV-beständig
	Farbe	weiß, transluzent/ Grau, Granitoptik
	Maße	ca. B 44 x L 44 x H 45 cm
	Gewicht	ca. 6,5 kg
	EE-Klasse	A++ - E
	Leuchtmittel	Multicolor LED Leuchtmittel E27 max. 9W mit Fernbedienung EEK: A, max. 850 lm Lebensdauer: 50.000 Std.
	Fernbedienung	Funk
	Verkabelung	ca. 5 m Kabel, schwarz
	Spannung	230 V-, 50Hz
	Schutzklasse	II
	IP 44	für Aussenbereich geeignet

CUBE LED ACCU OUTDOOR



Modell	09-01-04
Material	PE seidenmatt, UV-beständig
Farbe	weiß, transluzent
Maße	ca. B 41 x L 41 x H 45 cm
Gewicht	ca. 6 kg
EE-Klasse	B
Leuchtmittel	Multicolor LEDs, max. 4 W, max 136 lm, Lebensdauer: 30000 Std.
Fernbedienung	IR
Akku (Li-Ion)	3,7 V / 2 x 2200 mAh Betriebsdauer 10 h
Ladegerät	100-240VAC, 50/60Hz, Vout 7.5V/0,6A
Schutzklasse	III (Produkt), II (Ladegerät)
IP 54	Für Außenbereich geeignet

CUBE CUSHIONS & GLASSTOP



NEW
Nicht Inklusiv: Glasplatte oder Sitzkissen
Not Including: Glass top or cushion
Non Inclus: Panneau de verre ou coussin

Modell	06-09-06 Sitzkissen Orange 06-09-05 Sitzkissen Rot 06-09-04 Sitzkissen Violett 06-09-03 Sitzkissen Grün 06-09-02 Sitzkissen Anthrazit
Material	Filz, 100% Wolle
Maße	B 40 x L 40 x H 0.5 cm
Gewicht	ca. 0.2 kg
Modell	06-09-01 Glastischplatte
Material	Sicherheitsglas, klar
Maße	B 40 x L 40 x H 0.5 cm
Gewicht	2,2 kg

Modell	06-09-06 Orange cushion 06-09-05 Red cushion 06-09-04 Purple cushion 06-09-03 Green cushion 06-09-02 Anthracite cushion
Material	Felt, 100% wool
Dimensions	W 40 x W 40 x H 0.5 cm
Weight	approx. 0.2 kg
Modell	06-09-01 Glasstop
Material	Safety glass, transparent
Dimensions	B 40 x L 40 x H 0.5 cm
Weight	2,2 kg

Modèle	06-09-06 Orange coussin 06-09-05 Rouge coussin 06-09-04 Pourpre coussin 06-09-03 Vert coussin 06-09-02 Anthracite coussin
Matériaux	Feutre, 100% laine
Dimensions	La 40 x Lo 40 x H 0.5 cm
Poids	env. 0.2 kg
Modèle	06-09-01 Panneau de verre
Matériaux	Verre de sécurité, transparent
Dimensions	B 40 x L 40 x H 0.5 cm
Poids	2,2 kg

COOLER LED ACCU OUTDOOR



Modell	14-01-02
Material	PE seidenmatt, UV-beständig
Farbe	weiß, transluzent
Maße	ca. Ø 46 cm, H 89 cm
Gewicht	ca. 10 kg
EE-Klasse	B
Leuchtmittel	Multicolor LEDs, max. 4 W, max 136 lm, life span: 30.000 h
Fernbedienung	IR
Akku (Li-Ion)	3,7 V / 2 x 2200mAh Betriebsdauer: 10h
Ladegerät	100-240VAC, 50/60Hz, Vout 7.5V/0,6A
Schutzklasse	III (Produkt), II (Ladegerät)
IP 54	Für Außenbereich geeignet

Model	14-01-02
Material	PE semi gloss, UV resistant
Colour	white, translucent
Dimensions	approx. ca. Ø 46 cm, H 89 cm
Weight	approx. 10 kg
EE-Class	B
illuminant	Multicolor LEDs, max. 4 W, max 136 lm, life span: 30.000 h
Remote control	IR
Battery (Li-Ion)	3,7V/2x2200mAh operating time 10h
Charger	100-240VAC, 50/60Hz, Vout 7.5V/0,6A
Protection Class	III (Product), II (Charger)
IP 54	for outdoor use

Modèle	14-01-02
Matériaux	PE satiné, résistant aux rayons UV
Couleur	blanc, translucide
Dimensions	env. Ø 46 cm, H 89 cm
Poids	env. 10 kg
Classe énergétique	B
Ampoule	LED multicolore, max 4 W max 136 lm, Durée de vie: 30000h
Commande	IR
Batterie (Li-Ion)	3,7V / 2 x 2200mAh, autonomie 10h
Chargeur	100-240VAC, 50/60Hz, Vout 7.5V/0,6A
Catégorie	III (Produit), II (Chargeur)
IP 54	pour utilisation extérieure
Partie	insérable et amovible
Dimensions	Ø 30 cm, H 32 cm

EN	Model	06-06-01-LED (White) 06-06-02-LED (Granite) NEW
	Material	PE semi gloss, UV resistant
	Colour	white, translucent/ Grey, Granite
	Dimensions	approx. W 44 x L 44 x H 45 cm
	Weight	approx. 6.5 kg
	EE-Class	A++ - E
	illuminant	LED multicolor light bulb E27, max. 9W with remote control EEC: A, max. 850 lm Life span: 50.000 h
	Remote Control	RF
	Cable	approx. 5 m cable, black
	Voltage	230 V-, 50Hz
	Protection Class	II
	IP 44	for outdoor use

FR	Modèle	06-06-01-LED (Blanc) 06-06-02-LED (Granite) NEW
	Matériaux	PE satiné, résistant aux rayons UV
	Couleur	blanc, translucide/ gris, granite
	Dimensions	env. La 44 x Lo 44 x H 45 cm
	Poids	env. 6,5 kg
	Classe énergétique	A++ - E
	Ampoule LED multicolore	E27 max. 9W avec télé- commande/ CÉ: A, max. 850 lm/ Durée de vie: 50.000 h
	Télécommande	Radio contrôle
	Câblage	env. 5 m, noir
	Tension	230 V-, 50Hz
	Catégorie	II
	IP 44	pour utilisation extérieure

Modèle	09-01-04
Matériaux	PE satiné, résistant aux rayons UV
Couleur	blanc, translucide
Dimensions	env. La 41 x Lo 41 x H 45 cm
Poids	env. 6 kg
Classe énergétique	B
Ampoule	LED multicolore, max 4 W max 136 lm, Durée de vie: 30000h
Commande	IR
Batterie (Li-Ion)	3,7V / 2 x 2200 mAh autonomie: 10 h
Chargeur	100-240 VAC, 50/60 Hz, Vout 7.5V/0,6A
Catégorie	III (Objet), II (Chargeur)
IP 54	pour utilisation extérieure

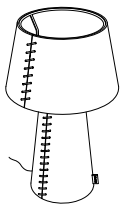

ALICE



ALICE LED



Modell	29-01-01
Material	Filz (PE)
Farbe	Grau
Maße	Ø 30 cm, H 50 cm
Maße Schirm	Ø 30 cm, H 18 cm
Gewicht	1,8 Kg
EE-Klasse	A++ - E
Leuchtmittel	1x MAX 12 W
Verkabelung	1,3 m, transluzent
Spannung	230 V-, 50Hz
Schutzklasse	II
IP 20	für Innenbereich geeignet

Model	29-01-01
Material	Felt (PE)
Colour	Grey
Dimensions	Ø 30 cm, H 50 cm
Shade size	Ø 30 cm, H 18 cm
Weight	1,8 Kg
EE-Class	A++ - E
Illuminant	1x MAX 12 W
Cable	1,3 m, translucent
Voltage	230 V-, 50Hz
Protection Class	II
IP 20	for indoor use

Modèle	29-01-01
Matériaux	Feutre (PE)
Couleur	Gris
Dimensions	Ø 30 cm, H 50 cm
Abat-jour	Ø 30 cm, H 18 cm
Poids	1,8 Kg
Classe énergétique	A++ - E
Ampoule	1x MAX 12 W
Câblage	1,3 m, transparent
Tension	230 V-, 50Hz
Catégorie	II
IP 20	pour utilisation intérieur

Modell	29-01-01-LED
Material	Filz (PE)
Farbe	Grau
Maße	Ø 30 cm, H 50 cm
Maße Schirm	Ø 30 cm, H 18 cm
Gewicht	1,8 Kg
EE-Klasse	A++ - E
Leuchtmittel	Multicolor LED Leuchtmittel E27 max. 9 W mit Fernbedienung EEK: A, max. 850 lm Lebensdauer: 50.000 Std.
Fernbedienung	Funk
Verkabelung	1,3 m, transluzent
Spannung	230 V-, 50Hz
Schutzklasse	II
IP 20	für Innenbereich geeignet

Model	29-01-01-LED
Material	Felt (PE)
Colour	Grey
Dimensions	Ø 30 cm, H 50 cm
Shade size	Ø 30 cm, H 18 cm
Weight	1,8 Kg
EE-Class	A++ - E
Illuminant	LED multicolor light bulb E27, max. 9 W with remote control EEC: A, max. 850 lm Life span: 50.000 h
Remote Control	RF
Cable	1,3 m, translucent
Voltage	230 V-, 50Hz
Protection Class	II
IP 20	for indoor use

Modèle	29-01-01-LED
Matériaux	Feutre (PE)
Couleur	Gris
Dimensions	Ø 30 cm, H 50 cm
Abat-jour	Ø 30 cm, H 18 cm
Poids	1,8 Kg
Classe énergétique	A++ - E
Ampoule	LED multicolore E27 max. 9 W avec télécommande/ CÉ: A, max. 850 lm/ Durée de vie: 50.000 h
Télécommande	Radio contrôle
Câblage	1,3 m, transparent
Tension	230 V-, 50Hz
Catégorie	II
IP 20	pour utilisation intérieur

NEW

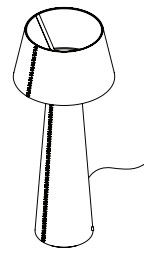

ALICE XL



ALICE XL LED



Modell	29-02-01
Material	Filz (PE)
Farbe	Grau
Maße	Ø 70 cm, H 172 cm
Maße Schirm	Ø 70 cm, H 40 cm
Gewicht	15,8 Kg
EE-Klasse	A++ - E
Leuchtmittel	1x MAX 60 W
Verkabelung	2,2 m transluzent
Spannung	230 V-, 50Hz
Schutzklasse	II
IP 20	für Innenbereich geeignet

Model	29-02-01
Material	Felt (PE)
Colour	Grey
Dimensions	Ø 70 cm, H 172 cm
Shade size	Ø 70 cm, H 40 cm
Weight	15,8 Kg
EE-Class	A++ - E
Illuminant	1x MAX 60 W
Cable	2,2 m translucent
Voltage	230 V-, 50Hz
Protection Class	II
IP 20	for indoor use

Modèle	29-02-01
Matériaux	Feutre (PE)
Couleur	Gris
Dimensions	Ø 70 cm, H 172 cm
Abat-jour	Ø 70 cm, H 40 cm
Poids	15,8 Kg
Classe énergétique	A++ - E
Ampoule	1x MAX 60 W
Câblage	2,2 m, transparent
Tension	230 V-, 50Hz
Catégorie	II
IP 20	pour utilisation intérieur

Modell	29-02-01-LED
Material	Filz (PE)
Farbe	Grau
Maße	Ø 70 cm, H 172 cm
Maße Schirm	Ø 70 cm, H 40 cm
Gewicht	15,8 Kg
EE-Klasse	A++ - E
Leuchtmittel	Multicolor LED Leuchtmittel E27 max. 9 W mit Fernbedienung EEK: A, max. 850 lm Lebensdauer: 50.000 Std.
Fernbedienung	Funk
Verkabelung	2,2 m transluzent
Spannung	230 V-, 50Hz
Schutzklasse	II
IP 20	für Innenbereich geeignet

Model	29-02-01-LED
Material	Felt (PE)
Colour	Grey
Dimensions	Ø 70 cm, H 172 cm
Shade size	Ø 70 cm, H 40 cm
Weight	15,8 Kg
EE-Class	A++ - E
Illuminant	LED multicolor light bulb E27, max. 9 W with remote control EEC: A, max. 850 lm Life span: 50.000 h
Remote Control	RF
Cable	2,2 m translucent
Voltage	230 V-, 50Hz
Protection Class	II
IP 20	for indoor use

Modèle	29-02-01-LED
Matériaux	Feutre (PE)
Couleur	Gris
Dimensions	Ø 70 cm, H 172 cm
Abat-jour	Ø 70 cm, H 40 cm
Poids	15,8 Kg
Classe énergétique	A++ - E
Ampoule	LED multicolore E27 max. 9 W avec télécommande/ CÉ: A, max. 850 lm/ Durée de vie: 50.000 h
Télécommande	Radio contrôle
Câblage	2,2 m, transparent
Tension	230 V-, 50Hz
Catégorie	II
IP 20	pour utilisation intérieur

NEW

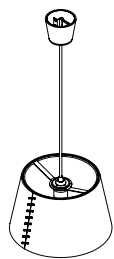
ALICE 30
PENDANT

NEW



ALICE 30 LED

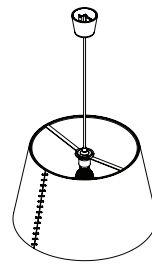

NEW

ALICE 50
PENDANT

NEW



ALICE 50 LED



DE

Modell	29-03-01
Material	Filz (PE)
Farbe	Grau
Maße	Ø 30 cm, H 18 cm
Gewicht	0,7 Kg
EE-Klasse	A++ - E
Leuchtmittel	1x MAX 25 W
Verkabelung	1,8 m, rot textilmantelt
Spannung	230 V-, 50Hz
Schutzklasse	II
IP 20	für Innenbereich geeignet

Modell	29-03-01-LED
Material	Filz (PE)
Farbe	Grau
Maße	Ø 30 cm, H 18 cm
Gewicht	0,7 Kg
EE-Klasse	A++ - E
Leuchtmittel	Multicolor LED Leuchtmittel E27 max. 9 W mit Fernbedienung EEK: A, max. 850 lm Lebensdauer: 50.000 Std.
Fernbedienung	Funk
Verkabelung	1,8 m, rot textilmantelt
Spannung	230 V-, 50Hz
Schutzklasse	II
IP 20	für Innenbereich geeignet

Modell	29-04-01
Material	Filz (PE)
Farbe	Grau
Maße	Ø 50 cm, H 30 cm
Gewicht	1,2 Kg
EE-Klasse	A++ - E
Leuchtmittel	1x MAX 25 W
Verkabelung	1,8 m, rot textilmantelt
Spannung	230 V-, 50Hz
Schutzklasse	II
IP 20	für Innenbereich geeignet

Modell	29-04-01-LED
Material	Filz (PE)
Farbe	Grau
Maße	Ø 50 cm, H 30 cm
Gewicht	1,2 Kg
EE-Klasse	A++ - E
Leuchtmittel	Multicolor LED Leuchtmittel E27 max. 9 W mit Fernbedienung EEK: A, max. 850 lm Lebensdauer: 50.000 Std.
Fernbedienung	Funk
Verkabelung	1,8 m, rot textilmantelt
Spannung	230 V-, 50Hz
Schutzklasse	II
IP 20	für Innenbereich geeignet

EN

Model	29-03-01
Material	Felt (PE)
Colour	Grey
Dimensions	Ø 30 cm, H 18 cm
Weight	0,7 Kg
EE-Class	A++ - E
Illuminant	1x MAX 25 W
Cable	1,8 m, red textile
Voltage	230 V-, 50Hz
Protection Class	II
IP 20	for indoor use

Model	29-03-01-LED
Material	Felt (PE)
Colour	Grey
Dimensions	Ø 30 cm, H 18 cm
Weight	0,7 Kg
EE-Class	A++ - E
Illuminant	LED multicolor light bulb E27, max. 9 W with remote control EEC: A, max. 850 lm Life span: 50.000 h
Remote Control	RF
Cable	1,8 m, red textile
Voltage	230 V-, 50Hz
Protection Class	II
IP 20	for indoor use

Model	29-04-01
Material	Felt (PE)
Colour	Grey
Dimensions	Ø 30 cm, H 50 cm
Weight	1,2 Kg
EE-Class	A++ - E
Illuminant	1x MAX 25 W
Cable	1,8 m, red textile
Voltage	230 V-, 50Hz
Protection Class	II
IP 20	for indoor use

Model	29-04-01-LED
Material	Felt (PE)
Colour	Grey
Dimensions	Ø 30 cm, H 50 cm
Weight	1,2 Kg
EE-Class	A++ - E
Illuminant	LED multicolor light bulb E27, max. 9 W with remote control EEC: A, max. 850 lm Life span: 50.000 h
Remote Control	RF
Cable	1,8 m, red textile
Voltage	230 V-, 50Hz
Protection Class	II
IP 20	for indoor use

FR

Modèle	29-03-01
Matériaux	Feutre (PE)
Couleur	Gris
Dimensions	Ø 30 cm, H 18 cm
Poids	0,7 Kg
Classe énergétique	A++ - E
Ampoule	1x MAX 25 W
Câblage	1,8 m, rouge
Tension	230 V-, 50Hz
Catégorie	II
IP 20	pour utilisation intérieur

Modèle	29-03-01-LED
Matériaux	Feutre (PE)
Couleur	Gris
Dimensions	Ø 30 cm, H 18 cm
Poids	0,7 Kg
Classe énergétique	A++ - E
Ampoule	Ampoule LED multicolours E27 max. 9 W avec télécommande CE: A, max. 850 lm Durée de vie: 50.000 h
Télécommande	Radio contrôle
Câblage	1,8 m, rouge
Tension	230 V-, 50Hz
Catégorie	II
IP 20	pour utilisation intérieur

Modèle	29-04-01
Matériaux	Feutre (PE)
Couleur	Gris
Dimensions	Ø 30 cm, H 50 cm
Poids	1,2 Kg
Classe énergétique	A++ - E
Ampoule	1x MAX 25 W
Câblage	1,8 m, rouge
Tension	230 V-, 50Hz
Catégorie	II
IP 20	pour utilisation intérieur

Modèle	29-04-01-LED
Matériaux	Feutre (PE)
Couleur	Gris
Dimensions	Ø 30 cm, H 50 cm
Poids	1,2 Kg
Classe énergétique	A++ - E
Ampoule	Ampoule LED multicolours E27 max. 9 W avec télécommande CE: A, max. 850 lm Durée de vie: 50.000 h
Télécommande	Radio contrôle
Câblage	1,8 m, rouge
Tension	230 V-, 50Hz
Catégorie	II
IP 20	pour utilisation intérieur

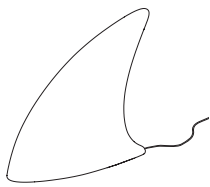

SHARK INDOOR



Modell	26-01-01
Material	PE seidenmatt, UV-beständig
Farbe	weiß, transluzent
Maße	ca. L 70 x B 19,5 x H 65 cm
Gewicht	ca. 2,5 kg
EE-Klasse	A++ - E
Leuchtmittel	1x max. 20 W E27
Verkabelung	ca. 2,6 m mit Fußschalter, klar
Spannung	230 V~, 50Hz
Schutzklasse	II
IP 20	für Innenbereich geeignet

Model	26-01-01
Material	PE semi gloss, UV resistant
Colour	white, translucent
Dimensions	approx. L 70 x W 9,5 x H 65 cm
Weight	approx. 2.5 kg
EE-Class	A++ - E
Illuminant	1x max. 20 W E27
Cable	approx. 2.6 m cable, clear
Voltage	230 V~, 50 Hz
Protection Class	II
IP 20	for indoor use

Modèle	26-01-01
Matériaux	PE satiné, résistant aux rayons UV
Couleur	blanc, translucide
Dimensions	env. L 70 x B 19,5 x H 65 cm
Poids	env. 2,5 kg
Classe énergétique	A++ - E
Ampoule	1x max. 20 W E27
Câblage	env. 2,6 m, transparent
Tension	230 V~, 50Hz
Catégorie	II
IP 20	pour utilisation intérieur



SHARK INDOOR LED



Modell	26-01-01-LED
Material	PE seidenmatt, UV-beständig
Farbe	weiß, transluzent
Maße	ca. L 70 x B 19,5 x H 65 cm
Gewicht	ca. 2,5 kg
EE-Klasse	A++ - E
Leuchtmittel	Multicolor LED Leuchtmittel E27 max. 9 W mit Fernbedienung EEK: A, max. 850 lm Lebensdauer: 50.000 Std.
Fernbedienung	Funk
Verkabelung	ca. 2,6 m mit Fußschalter, klar
Spannung	230 V~, 50 Hz
Schutzklasse	II
IP 20	für Innenbereich geeignet

Model	26-01-01-LED
Material	PE semi gloss, UV resistant
Colour	white, translucent
Dimensions	approx. L 70 x W 9,5 x H 65 cm
Weight	approx. 2.5 kg
EE-Class	A++ - E
Illuminant	LED multicolor light bulb E27, max. 9 W with remote control EEC: A, max. 850 lm Life span: 50.000 h
Remote Control	RF
Cable	approx. 2.6 m cable, clear
Voltage	230 V~, 50 Hz
Protection Class	II
IP 20	for indoor use

Modèle	26-01-01-LED
Matériaux	PE satiné, résistant aux rayons UV
Couleur	blanc, translucide
Dimensions	env. L 70 x B 19,5 x H 65 cm
Poids	env. 2,5 kg
Classe énergétique	A++ - E
Ampoule	Ampoule LED multicolours E27 max. 9 W avec télécommande CE: A, max. 850 lm Durée de vie: 50.000 h
Télécommande	Radio contrôle
Câblage	env. 2,6 m, transparent
Tension	230 V~, 50 Hz
Catégorie	II
IP 20	pour utilisation intérieur

SHARK OUTDOOR



Modell	26-02-01
Material	PE seidenmatt, UV-beständig
Farbe	weiß, transluzent
Maße	ca. L 70 x B 19,5 x H 65 cm
Gewicht	ca. 3,2 kg
EE-Klasse	A++ - E
Leuchtmittel	1x max. 20 W E27
Verkabelung	ca. 4,6 m Kabel, schwarz
Spannung	230 V~, 50Hz
Schutzklasse	II
IP 44	für Aussenbereich geeignet

Model	26-02-01
Material	PE semi gloss, UV resistant
Colour	white, translucent
Dimensions	approx. L 70 x W 9,5 x H 65 cm
Weight	approx. 3.2 kg
EE-Class	A++ - E
Illuminant	1x max. 20 W E27
Cable	approx. 4.6 m cable, black
Voltage	230 V~, 50Hz
Protection Class	II
IP 44	for outdoor use

Modèle	26-02-01
Matériaux	PE satiné, résistant aux rayons UV
Couleur	blanc, translucide
Dimensions	env. L 70 x B 19,5 x H 65 cm
Poids	env. 3,2 kg
Classe énergétique	B
Ampoule	1x max. 20 W E27
Câblage	env. 4,6 m, noir
Tension	230 V~, 50Hz
Catégorie	II
IP 44	pour utilisation extérieure



SHARK OUTDOOR LED



Modell	26-02-01-LED
Material	PE seidenmatt, UV-beständig
Farbe	weiß, transluzent
Maße	ca. L 70 x B 19,5 x H 65 cm
Gewicht	ca. 3,2 kg
EE-Klasse	A++ - E
Leuchtmittel	Multicolor LED Leuchtmittel E27 max. 9 W mit Fernbedienung EEK: A, max. 850 lm Lebensdauer: 50.000 Std.
Fernbedienung	Funk
Verkabelung	ca. 4,6 m Kabel, schwarz
Spannung	230 V~, 50 Hz
Schutzklasse	II
IP 44	für Aussenbereich geeignet

Model	26-02-01-LED
Material	PE semi gloss, UV resistant
Colour	white, translucent
Dimensions	approx. L 70 x W 9,5 x H 65 cm
Weight	approx. 3.2 kg
EE-Class	A++ - E
Illuminant	LED multicolor light bulb E27, max. 9 W with remote control EEC: A, max. 850 lm Life span: 50.000 h
Remote Control	RF
Cable	approx. 4.6 m cable, black
Voltage	230 V~, 50 Hz
Protection Class	II
IP 44	for outdoor use

Modèle	26-02-01-LED
Matériaux	PE satiné, résistant aux rayons UV
Couleur	blanc, translucide
Dimensions	env. L 70 x B 19,5 x H 65 cm
Poids	env. 3,2 kg
Classe énergétique	A++ - E
Ampoule	Ampoule LED multicolours E27 max. 9 W avec télécommande CE: A, max. 850 lm Durée de vie: 50.000 h
Télécommande	Radio contrôle
Câblage	env. 4,6 m, noir
Tension	230 V~, 50 Hz
Catégorie	II
IP 44	pour utilisation extérieure

SHARK OUTDOOR LED ACCU



Modell	26-03-01
Material	PE seidenmatt, UV-beständig
Farbe	weiß, transluzent
Maße	ca. L 70 x B 19,5 x H 65 cm
Gewicht	ca. 2,5 kg
EE-Klasse	B
Leuchtmittel	Multicolor LEDs, max. 4 W, max 136 lm, Lebensdauer: 30000 Std.
Fernbedienung	IR
Akku (Li-Ion)	3,7V / 2 x 2200 mAh Betriebsdauer 10 h
Ladegerät	100-240 VAC, 50/60 Hz, Vout 7.5V/0,6 A
Schutzklasse	III (Produkt), II (Ladegerät)
IP 44	Für Außenbereich geeignet

Model	26-03-01
Material	PE semi gloss, UV resistant
Colour	white, translucent
Dimensions	approx. L 70 x W 9,5 x H 65 cm
Weight	approx. 2.5 kg
EE-Class	B
Illuminant	Multicolor LEDs, max. 4 W, max 136 lm, life span: 30.000 h
Remote control	IR
Battery (Li-Ion)	3.7V / 2 x 2200 mAh operating time 10 h
Charger	100-240 VAC, 50/60 Hz, Vout 7.5V/0,6 A
Protection Class	III (Product), II (Charger)
IP 44	for outdoor use

Modèle	26-03-01
Matériaux	PE satiné, résistant aux rayons UV
Couleur	blanc, translucide
Dimensions	env. L 70 x B 19,5 x H 65 cm
Poids	env. 2,5 kg
Catégorie énergétique	B
Ampoule	LED multicolours, max 4 W max 136 lm, Durée de vie: 30000h
Commande	IR
Batterie (Li-Ion)	3,7V / 2 x 2200 mAh autonomie: 10 h
Chargeur	100-240 VAC, 50/60 Hz, Vout 7.5V/0,6 A
Catégorie	III (Produit), II (Chargeur)
IP 44	pour utilisation extérieure

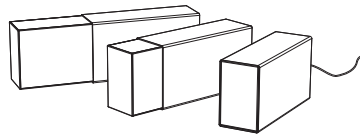

ERASER 260

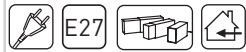

ERASER 260 LED



ERASER 380



ERASER 380 LED



ED

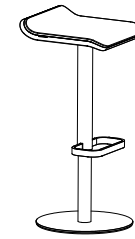

DE

Modell	Silber 10-02-01 Champagner 10-02-02
Material	eloxiertes Aluminium, PMMA
Farbe	PMMA weiß, transluzent
Maße	260 x 95 x 146 mm; stufenlos ausziehbar bis 460 mm
Gewicht	ca. 1,4 kg
EE-Klasse	A++ - E
Leuchtmittel	1x max. 11 W/ E27
Verkabelung	ca. 2 m Kabel, schwarz
Spannung	230 V~, 50 Hz
Schutzklasse	II
IP 20	für Innenbereich geeignet

Modell	Silber 10-02-01-LED Champagner 10-02-02-LED
Material	eloxiertes Aluminium, PMMA
Farbe	PMMA weiß, transluzent
Maße	260 x 95 x 146 mm; stufenlos ausziehbar bis 460 mm
Gewicht	ca. 1,4 kg
EE-Klasse	A++ - E
Leuchtmittel	Multicolor LED Leuchtmittel E27 max. 9 W mit Fernbedienung EEK: A, max. 850 lm Lebensdauer: 50.000 Std.
Verkabelung	ca. 2 m Kabel, schwarz
Spannung	230 V~, 50 Hz
Schutzklasse	II
IP 20	für Innenbereich geeignet

Modell	Silber 10-01-01 Champagner 10-01-02
Material	eloxiertes Aluminium, PMMA
Farbe	PMMA weiß, transluzent
Maße	380 x 131 x 208 mm; stufenlos ausziehbar bis 680 mm
Gewicht	ca. 3,1 kg
EE-Klasse	A++ - E
Leuchtmittel	1x max. 15 W/ E27
Verkabelung	ca. 2 m Kabel, schwarz
Spannung	230 V~, 50 Hz
Schutzklasse	II
IP 20	für Innenbereich geeignet

Modell	Silber 10-01-01-LED Champagner 10-01-02-LED
Material	eloxiertes Aluminium, PMMA
Farbe	PMMA weiß, transluzent
Maße	380 x 131 x 208 mm; stufenlos ausziehbar bis 680 mm
Gewicht	ca. 3,1 kg
EE-Klasse	A++ - E
Leuchtmittel	Multicolor LED Leuchtmittel E27 max. 9 W mit Fernbedienung EEK: A, max. 850 lm Lebensdauer: 50.000 Std.
Verkabelung	ca. 2 m Kabel, schwarz
Spannung	230 V~, 50 Hz
Schutzklasse	II
IP 20	für Innenbereich geeignet

Modell	13-02-03 (weiß) 13-02-01 (anthrazit)
Material	Formholz lackiert/ Mittelteil: Stahl pulverbeschichtet-Edelstahl/ Edelstahl- Fuss gebürstet
Farbe	Weiß/weiß (Mod. 13-02-03) Weiß/anthrazit (Mod. 13-02-01)
Maße	L 38 x B 35 x H 81 cm max/ min Höhe: 81/ 55,5 cm
Sitzhöhe	max/ min: 77/ 51,5 cm
Gewicht	13 kg
Andere Farben auf Anfrage möglich	

EN

Model	Silver 10-02-01 Champagne 10-02-02
Material	anodized aluminium, PMMA
Colour	PMMA, white, translucent
Dimensions	260 x 95 x 146 mm; extendable to a length of 460 mm
Weight	approx. 1.4 kg
EE-Class	A++ - E
Illuminant	1x max. 11 W/ E27
Cable	approx. 2 m cable, black
Voltage	230V~, 50Hz
Protection Class	II
IP 20	for indoor use

Model	Silver 10-02-01-LED Champagne 10-02-02-LED
Material	anodized aluminium, PMMA
Colour	PMMA, white, translucent
Dimensions	260 x 95 x 146 mm; extendable to a length of 460 mm
Weight	approx. 1.4 kg
EE-Class	A++ - E
Illuminant	LED multicolor light bulb E27, max. 9 W with remote control EEC: A, max. 850 lm Life span: 50.000 h
Cable	approx. 2 m cable, black
Voltage	230 V~, 50 Hz
Protection Class	II
IP 20	for indoor use

Model	Silver 10-01-01 Champagne 10-01-02
Material	anodized aluminium, PMMA
Colour	PMMA, white, translucent
Dimensions	380 x 131 x 208 mm; extendable to a length of 680 mm
Weight	approx. 3.1 kg
EE-Class	A++ - E
Illuminant	1x max. 15 W/ E27
Cable	approx. 2m, black
Voltage	230 V~, 50 Hz
Protection Class	II
IP 20	for indoor use

Model	Silver 10-01-01-LED Champagne 10-01-02-LED
Material	anodized aluminium, PMMA
Colour	PMMA, white, translucent
Dimensions	380 x 131 x 208 mm; extendable to a length of 680 mm
Weight	approx. 3.1 kg
EE-Class	A++ - E
Illuminant	LED multicolor light bulb E27, max. 9 W with remote control EEC: A, max. 850 lm Life span: 50.000 h
Cable	approx. 2m, black
Voltage	230 V~, 50 Hz
Protection Class	II
IP 20	for indoor use

Model	13-02-03 (white) 13-02-01 (anthracite)
Material	Wood painted/ Column: Powder-coated steel+stainless steel/ Brushed stainless steel foot
Colour	White/ white (Mod. 13-02-03) White/ anthracite (Mod. 13-02-01)
Dimensions	L 38 x W 35 x H 81 cm max/min height: 81/ 55.5 cm
Seat height	max/ min: 77/ 51.5 cm
Weight	13 kg
Other colours available on request	

FR

Modèle	Argenté 10-02-01 Champagne 10-02-02
Matériaux	aluminium anodisé, PMMA
Couleur	PMMA, blanc, translucide
Dimensions	260 x 95 x 146 mm, extensible à une longueur de 460 mm
Poids	env. 1,4 kg
Classe énergétique	A++ - E
Ampoule	1x max. 11 W/ E27
Câblage	env. 2 m, noir
Tension	230 V~, 50 Hz
Catégorie	II
IP 20	pour utilisation intérieur

Modèle	Argenté 10-02-01-LED Champagne 10-02-02-LED
Matériaux	aluminium anodisé, PMMA
Couleur	PMMA, blanc, translucide
Dimensions	260 x 95 x 146 mm, extensible à une longueur de 460 mm
Poids	env. 1,4 kg
Classe énergétique	A++ - E
Ampoule	Ampoule LED multicolours E27 max. 9 W avec télécommande CE: A, max. 850 lm Durée de vie: 50.000 h
Câblage	env. 2 m, noir
Tension	230 V~, 50 Hz
Catégorie	II
IP 20	pour utilisation intérieur

Modèle	Argenté 10-01-01 Champagne 10-01-02
Matériaux	aluminium anodisé, PMMA
Couleur	PMMA, blanc, translucide
Dimensions	380 x 131 x 208 mm, extensible à une longueur de 680 mm
Poids	env. 3,1 kg
Classe énergétique	A++ - E
Ampoule	1x max. 15 W/ E27
Câblage	env. 2 m, noir
Tension	230 V~, 50 Hz
Catégorie	II
IP 20	pour utilisation intérieur

Modèle	Argenté 10-01-01-LED Champagne 10-01-02-LED
Matériaux	aluminium anodisé, PMMA
Couleur	PMMA, blanc, translucide
Dimensions	380 x 131 x 208 mm, extensible à une longueur de 680 mm
Poids	env. 3,1 kg
Classe énergétique	A++ - E
Ampoule	Ampoule LED multicolours E27 max. 9 W avec télécommande CE: A, max. 850 lm Durée de vie: 50.000 h
Câblage	env. 2 m, noir
Tension	230 V~, 50 Hz
Catégorie	II
IP 20	pour utilisation intérieur

Modèle	13-02-03 (blanc) 13-02-01 (anthracite)
Matériaux	Bois, laqué/ Colonne: Acier revêtuement en poudre-acier inoxydable/ Pied en acier inoxydable, brossé
Couleur	Blanc/ blanc (Mod. 13-02-03) Blanc/ anthracite (Mod. 13-02-01)
Dimensions	L 38 x L 35 x H 81 cm max/min hauteur: 81/ 55.5 cm
Hauteur du siège	max/ min: 77/ 51.5 cm
Poids	13 kg
Autres couleurs disponibles sur demande	



9W MULTICOLOUR LED LIGHT BULB



Mod. 20-02-01 9W RGBW LEUCHTMITTEL

Material Aluminium, Kunststoff

Farbe silber, weiß

Maße Ø ca. 60 mm, H 122 mm

Gewicht ca. 0,12 kg

Leuchtmittel Multicolor LED Leuchtmittel E27, MAX 9W mit Fernbedienung

EE-Klasse A Lm: Max. 850 (weiß)

Spannung AC 85-240 V, 50-60 Hz

Lebensdauer 50.000 Std.

Fernbedienung Funk [2.4 GHz]

Funktionen

- 9 Programme
- Dimmfunktion
- Multicolor
- Warm-weißes Licht
- 4-Kanal-Steuerung
- Reichweite bis zu 25m
- Kompatibel mit iPhone und Android [mit WIFI-Controller Mod. 20-02-03]

Mod. 20-02-01 9W RGBW LIGHT BULB

Material Aluminium, plastic

Colour silver, white

Dimensions Ø approx. 60 mm, H 122 mm

Weight approx. 0.12 kg

Illuminant LED multicolor light bulb E27, MAX 9W with radio remote control

EE-Class A Lm: Max. 850 (white)

Voltage AC 85-240 V, 50-60 Hz

Product Life 50.000 h

Remote Control RF [2.4 GHz]

Functions

- 9 programmes
- Brightness control
- Entire RGB spectrum
- Warm white light
- 4 Channel controls
- A range of up to 25 m
- Compatible with iOS and Android with Moree WiFi Controller Mod. 20-02-03

Mod. 20-02-01 9W RGBW AMPOULE

Matériaux aluminium, plastique

Couleur argentée, blanc

Dimensions Ø env. 60 mm, H 122 mm

Poids env. 0,12 kg

Ampoule Ampoule LED multicolours E27, MAX 9W avec télécommande

Classe énergétique A Lm: Max. 850 (blanc)

Tension AC 85-240 V, 50-60 Hz

Durée de vie 50.000 h

Commande Télécommande radio [2.4 GHz]

Fonctions

- 9 programmes
- 4 contrôles de la Manche
- multicolours
- Contrôle d'intensité
- lumière blanche
- Une gamme de jusqu'à 25 m
- Compatible avec iPhone et Android (avec Moree Wifi Contrôleur)



RADIO REMOTE CONTROLLER



Mod. 20-02-02 FERNBEDIENUNG

Für RGBW LED-Leuchtmittel (Mod. 20-02-01) und Moree 2.4 GHz LED/ LED PRO/ LED PRO ACCU Produkte

Funktionen

- 9 voreingestellte Farben
- Dimmfunktion
- Multicolor
- Warm-weißes Licht
- 4-Kanal-Steuerung
- Reichweite bis zu 25 m

Gewicht 53 g

Maße W 53 x L x 120 x H 20 mm

Signal RF 2.4 GHz

Batterien 2 x AAA (nur Alkaline)

Mod. 20-02-02 REMOTE CONTROL

For RGBW LED Light bulb and Moree 2.4GHz LED/ LED PRO/ LED PRO ACCU Products.

Functions

- 9 programmes
- Brightness Control
- Multicolour
- Warm white light setting
- 4 Channel controls
- A range of upto 25 meters

Gewicht 53 g

Maße W 53 x L x 120 x H 20 mm

Signal RF 2.4 GHz

Batteries 2 x AAA (Alkaline only)

Mod. 20-02-02 TÉLÉCOMMANDE

Pour ampoule RGBW LED et Moree 2.4 GHz LED/ LED PRO/ LED PRO ACCU produits.

Fonctions

- 9 programmes
- Fonction de gradation
- Multicolore
- Lumière blanche chaude
- 4 contrôles sur 4 canaux
- Portée jusqu'à 25 m

Poids 53 g

Dimensions W 53 x L x 120 x H 20 mm

Signal RF 2.4 GHz

Batteries 2 x AAA (seulement Alcalin)

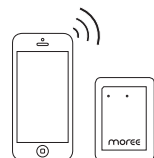

MOREE REMOTE APP & WIFI CONTROLLER



Mod. 20-02-03 WIFI-CONTROLLER

Verwenden Sie den WIFI-Controller um Moree 9W RGBW LED - Leuchtmittel und/ oder Moree LED Pro 2.4 GHz Produkte mit Ihrem Smartphone zu verbinden und zu steuern.

Funktionen

- Kompatibel mit iPhone und Android
- 9 Programme
- Dimmfunktion
- Multicolor
- Warm-weißes Licht
- 4-Kanal-Steuerung
- Reichweite bis zu 25 m

Material Kunststoff

Gewicht 42 g

Spannung DC/5V, 0,5/1 A

Maße W 60 x L 90 x H 15 mm

Signal RF 2.4 GHz

Mod. 20-02-03 WIFI-CONTROLLER

Use your iPhone or Android Device to link to a WIFI Controller and control your Moree RGBW LED Lightbulb and Moree 2.4 GHz LED Pro Products.

Functions

- Compatible with iPhone and Android
- 9 programmes
- Brightness control
- Multicolour
- Warm white light setting
- 4 Channel controls
- A range of upto 25 meters

Material Plastic

Weight 42 g

Power supply DC/5V, 0,5/1 A

Dimensions W 60 x L 90 x H 15 mm

Signal RF 2.4 GHz

Mod. 20-02-03 CONTRÔLEUR WIFI

Utilisez le contrôleur WIFI pour relier et contrôler vos Moree RGBW LED Ampoule et Moree 2.4 GHz LED Pro Produits avec votre appareil mobile.

Fonctions

- Compatible avec iPhone et Android
- 9 programmes
- Fonction de gradation
- Multicolore
- Lumière blanche chaude
- 4 contrôles sur 4 canaux
- Portée jusqu'à 25 m

Matériaux Plastique

Poids 42 g

Source de courant DC/5V, 0,5/1 A

Dimensions W 60 x L 90 x H 15 mm

Signal RF 2.4 GHz

| KONTAKT | CONTACT | A CONTACTER

FACHHÄNDLER

<http://www.moree.de/haendler/>

KATALOG ALS PDF

<http://www.moree.de/katalog-flyer/>

TEXTE, BILDER & BEDIENUNGSANLEITUNGEN

Aktuelle Informationen zu unseren Produkten finden Sie im Internet: www.moree.de

MOREE NEWS <http://www.moree.de/news/>

BESUCHEN SIE UNS AUF FACEBOOK

www.facebook.com/moree.de

MOREE® ist markenrechtlich geschützt.

Änderungen an den Produkten vorbehalten.

Jegliche Haftung für den Fall von Irrtümern oder Auslassungen wird ausgeschlossen.

Apple, das Apple-Logo und iPhone sind Warenzeichen von Apple Inc., welche in den USA und anderen Ländern eingetragen sind. App Store ist eine Dienstleistungsmarke von Apple Inc. Android ist ein Warenzeichen von Google Inc.

RETAILER

<http://www.moree.de/en/retailer/>

CATALOGUE AS PDF

<http://www.moree.de/en/catalogue-flyer/>

TEXT, IMAGES & MANUALS

Refer to our website for the latest information about our products: www.moree.de

MOREE NEWS <http://www.moree.de/en/news/>

FIND US ON FACEBOOK

www.facebook.com/moree.de

MOREE® is a registered Trademark.

Changes to the products are reserved. All liability in case of errors or omissions is excluded.

Apple, the Apple logo and iPhone are trademarks of Apple Inc., registered in the U.S. and other countries. App Store is a service mark of Apple Inc. Android is a trademark of Google Inc.

DETAILLANTS

<http://www.moree.de/fr/vendeurs/>

CATALOGUE SOUS FORME.PDF

<http://www.moree.de/fr/brochure-depliant/>

TEXTES, IMAGES & GUIDES

Consultez notre site web pour les plus récentes mises-à-jour sur nos produits: www.moree.de

LES NOUVELLES DE MOREE

<http://www.moree.de/fr/news/>

RETROUVEZ-NOUS SUR FACEBOOK

www.facebook.com/moree.de

MOREE® est une marque déposée.

Tous changements aux produits sont réservés. Toute responsabilité en cas d'erreur ou d'omission est exclue. Apple, le logo Apple et iPhone sont des marques d'Apple Inc., déposées aux États-Unis et d'autres pays. App Store est une marque de service d'Apple Inc. Android est une marque déposée de Google Inc.

PROJEKTE
PROJECTS
PROJETS



BAR ROUGE/
BASEL/ SWITZERLAND

©MARGILGEN.COM



ESCAPE/
AMSTERDAM/ HOLLAND

©WWW.DENNISVELDMAN.NL / WWW.ESCAPE.NL



THE HILTON
BUDAPEST/

©THE HILTON HOTEL



MERCEDES CAFE/ MALDOVA

©HORECAGRUP SRL & TILUANA SRL



PLUS X AWARD/
COLOGNE/ GERMANY

©PLUS X



©RENTALOUNGE.BE



HOTEL/
HUNGARY

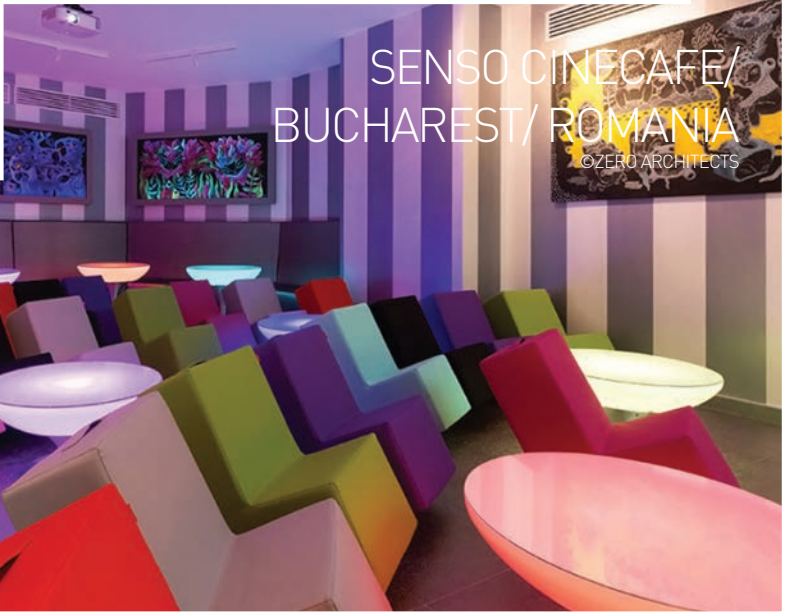

SENSO CINECAFE/
BUCHAREST/ROMANIA
©ZERO ARCHITECTS



ENTRANCE HALL/ GERMANY
©MOREE



EVENT/
BASEL/ SWITZERLAND
©WWW.BOSSE-EVENTSTYLING.DE

| PROJEKTE
| PROJECTS
| PROJETS

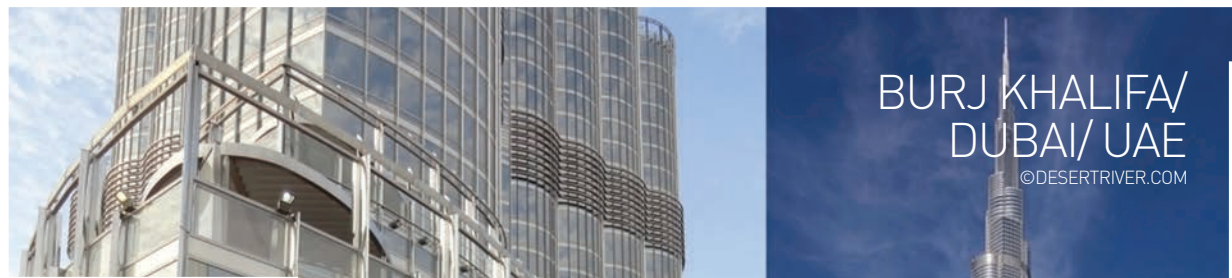

BURJ KHALIFA/
DUBAI/ UAE
©DESERTRIVER.COM



DISH/ DALLAS/ USA
©DISH



SUB SIX UNDERWATER
NIGHTCLUB/ MALDIVES
©SUB SIX



CORSO HOTEL & SPA/
IBIZA/ SPAIN
©TONI RAMON PLANELLS



RI CLUB

RI CLUB



AER CLUB/
STUTT GART/GERMANY

© AER CLUB



© CIALONA.NL

70 | 71



B1 CLUB/
BOCHUM/GERMANY

© B1 CLUB



THE ATTIC/
DÜSSELDORF/GERMANY

© MOREE

moree

ENHANCING AMBIANCE

moree

ENHANCING AMBIANCE

FIRMA/ COMPANY/ SOCIÉTÉ
Moree Ltd.
Kaiserswerther Markt 11
40489 Düsseldorf
Deutschland/ Germany/ Allemagne

AUSSTELLUNG/ SHOWROOM/
SALLE D'EXPOSITION
An St. Swibert 42
40489 Düsseldorf
Deutschland/ Germany/ Allemagne

KUNDENSERVICE/ CUSTOMER SERVICE/
SERVICE CLIENT
Tel. +49.211 302 768 - 0
Fax. +49.211 302 768 - 10
info@moree.de
www.moree.de